

# GRID INTEGRATION REQUIREMENTS FOR VARIABLE RENEWABLE ENERGY

## TECHNICAL GUIDE



---

© 2019 International Bank for Reconstruction and Development / The World Bank  
1818 H Street NW  
Washington DC 20433  
Telephone: 202-473-1000  
Internet: [www.worldbank.org](http://www.worldbank.org)

This work is a product of the staff of The World Bank with external contributions. The findings, interpretations, and conclusions expressed in this work do not necessarily reflect the views of The World Bank, its Board of Executive Directors, or the governments they represent.

The World Bank does not guarantee the accuracy of the data included in this work. The boundaries, colors, denominations, and other information shown on any map in this work do not imply any judgment on the part of The World Bank concerning the legal status of any territory or the endorsement or acceptance of such boundaries.

#### Rights and Permissions

The material in this work is subject to copyright. Because The World Bank encourages dissemination of its knowledge, this work may be reproduced, in whole or in part, for noncommercial purposes as long as full attribution to this work is given.

Any queries on rights and licenses, including subsidiary rights, should be addressed to World Bank Publications, The World Bank Group, , 1818 H Street NW, Washington, DC 20433, USA; fax: 202-522-2625; e-mail: [pubrights@worldbank.org](mailto:pubrights@worldbank.org). Furthermore, the ESMAP Program Manager would appreciate receiving a copy of the publication that uses this publication for its source sent in care of the address above, or to [esmap@worldbank.org](mailto:esmap@worldbank.org).

**Cover Image**—[42:366 The Power Grid](#). © Joe Strupek/Flickr. [CC BY-ND 2.0](#).

**Attribution**—Please cite the work as follows: ESMAP (Energy Sector Management Assistance Program) 2019. “Grid Integration Requirements for Variable Renewable Energy.” ESMAP Technical Guide, World Bank, Washington, DC.

**Acknowledgments**—The financial and technical support by the Energy Sector Management Assistance Program (ESMAP) is gratefully acknowledged. ESMAP—a global knowledge and technical assistance program administered by the World Bank—assists low- and middle-income countries to increase their know-how and institutional capacity to achieve environmentally sustainable energy solutions for poverty reduction and economic growth. ESMAP is funded by Australia, Austria, Canada, Denmark, the European Commission, Finland, France, Germany, Iceland, Italy, Japan, Lithuania, Luxembourg, the Netherlands, Norway, the Rockefeller Foundation, Sweden, Switzerland, the United Kingdom, and the World Bank.

---

# TABLE OF CONTENTS

<b>TECHNICAL GUIDES ON VRE GRID INTEGRATION: PREFACE</b> .....	<b>vii</b>
<b>ACKNOWLEDGEMENTS</b> .....	<b>xi</b>
<b>EXECUTIVE SUMMARY</b> .....	<b>xii</b>
<b>1   INTRODUCTION</b> .....	<b>1</b>
<b>2   VRE POWER PLANTS</b> .....	<b>3</b>
<b>SOLAR POWER</b> .....	<b>3</b>
Photovoltaic Generation Technology .....	<b>3</b>
Essential Considerations for Technical Specification.....	<b>8</b>
PV Power Plant Testing.....	<b>11</b>
<b>WIND POWER</b> .....	<b>15</b>
Onshore and Offshore Generation Technology.....	<b>15</b>
Wind Turbine Main Components .....	<b>15</b>
Wind Turbine Generator Types .....	<b>16</b>
Essential Considerations for Technical Specification.....	<b>19</b>
Wind Power Plant Testing.....	<b>22</b>
<b>3   VRE INTEGRATION INTO THE POWER SYSTEM</b> .....	<b>26</b>
<b>INTERCONNECTION OF RESOURCES</b> .....	<b>26</b>
<b>INTERCONNECTION STAGES</b> .....	<b>26</b>
Steady-State Analysis.....	<b>27</b>
Short-Circuit Study.....	<b>28</b>
Dynamic and Transient Stability Analysis .....	<b>28</b>
Facilities Study .....	<b>28</b>
<b>VRE INTEGRATION CHALLENGES</b> .....	<b>29</b>
<b>TECHNICAL REQUIREMENTS FOR VRE INTERCONNECTION</b> .....	<b>33</b>
<b>GRID CODE COMPLIANCE</b> .....	<b>40</b>
General Requirements.....	<b>40</b>
System Operation Requirements.....	<b>44</b>
Ancillary Services .....	<b>45</b>
Frequency Ride-Through.....	<b>47</b>
Voltage Ride-Through .....	<b>47</b>
Dynamic Overvoltages .....	<b>49</b>

---

Short-Circuit Current Contribution .....	50
Power Quality .....	51
DEVELOPMENT OF VRE-RELATED GRID CODE .....	52
<b>4   CONCLUSION: ESSENTIAL REQUIREMENTS FOR VRE GRID INTEGRATION .....</b>	<b>54</b>
<b>APPENDIX A: APPLICABLE STANDARDS .....</b>	<b>57</b>
<b>APPENDIX B: ADVANCED VRE INTERCONNECTION REQUIREMENTS .....</b>	<b>61</b>
BLACK-START CAPABILITY .....	61
FREQUENCY RESPONSE AND CONTROL .....	61
Synthetic Inertia.....	61
Over-Frequency Control .....	62
Under-Frequency Control .....	62
Automatic Generation Control .....	63
REACTIVE POWER CAPABILITIES FOR VOLTAGE CONTROL.....	64
CONGESTION MANAGEMENT .....	65
DEMAND RESPONSE .....	65
<b>REFERENCES .....</b>	<b>67</b>

# BOXES, FIGURES AND TABLES

Box 3.1: Case Studies: Brazil and Texas ..... 39

Box 3.2: Example 1: VRE Interconnection in Germany ..... 40

Box 3.3: Example 2: VRE Interconnection in Barbados - Small-Scale System..... 410

Box 3.4: Case Study: Wind Farm Integration ..... 43

Box 3.5: Case Study: ERCOT ..... 45

Figure 2.1: Solar PV Plant Main Components ..... 3

Figure 2.2: Sample P-Q capability curves from different transmission operators in Europe ..... 7

Figure 2.3: Module Manufacturing and Batch Quality Assurance Testing ..... 10

Figure 2.4: Wind Turbine Main Components..... 16

Figure 2.5: Onshore and Offshore Wind Power Plant Connection ..... 16

Figure 2.6: Type 3 Wind Turbine Diagram ..... 18

Figure 2.7: Type 4 Wind Turbine Diagram ..... 19

Figure 3.1: VRE’s Essential Abilities for Grid Integration ..... 32

Figure 3.2: Operation Range ..... 45

Figure 3.3: LVRT Requirement ..... 49

Figure B.1: Linearized Inertia Requirement from Wind Power Plants..... 62

Figure B.2: Reactive Power Available at POI vs. Voltage ..... 64

Figure B.3: Reactive Power Available at POI vs. Active Power of VRE..... 65

Table 2.1: Sample of Test Equipment for PPT..... 24

Table 3.1: Phases of VRE Integration ..... 30

Table 3.2: Major Differences between Wind and Solar PV..... 33

Table 3.3: Grid Integration Requirements ..... 36

Table 3.4: Overview of Voltage Levels in Germany ..... **Error! Bookmark not defined.**

Table 3.5: General Rules for Selecting the Voltage Level of the POI ..... 41

Table 3.6: Example of a Frequency-Duration Profile (for 60 Hz System)..... 47

Table 3.7: Example of Overvoltage Duration Thresholds ..... 49

Table 4.1: Checklist of Essential Requirements for VRE Grid Integration..... 55

---

# ACRONYMS AND ABBREVIATIONS

AC	alternating current
ACE	area control error
AGC	automatic generation control
ANSI	American National Standards Institute
CAGR	compound annual growth rate
CREZ	competitive renewable energy zones
CPS	control performance standards
CPT	control power transformer
CSP	concentrating solar power
DC	direct current
DFIG	doubly-fed induction generator
DOV	dynamic overvoltage
DR	demand response
DNI	direct normal irradiance
DRC	direct load control
DSM	demand side management
EL	Electroluminescence
EPI	energy performance index
EY	energy yield
FACTS	flexible alternating-current transmission system
FAS	future ancillary services
FES	flywheel energy storage
FERC	Federal Energy Regulatory Commission
FIS	full interconnection study
FFR	fast frequency response
FRT	frequency ride-through
GHI	global Horizontal Irradiation
GW	Gigawatt
HOV	harmonic overvoltage
HVAC	high-voltage alternating current

---

HVDC	high-voltage direct-current
HVRT	high-voltage ride-through
IE	interconnecting entity
IEC	International Electrotechnical Commission
IEEE	Institute of Electrical and Electronics Engineers
IGBT	insulated-gate bipolar transistor
IRENA	International Renewable Energy Agency
ITP	independent transmission project
kW	Kilowatt
LCOE	levelized cost of electricity
LVRT	low-voltage ride-through
MPP	maximum power point
MPPT	maximum power point tracking
MVA	megavolt-ampere
MW	Megawatt
NERC	North American Electric Reliability Corporation
NEMA	National Electrical Manufacturers Association
O&M	operation and maintenance
PCC	point of common coupling
PMP	power measurement panel
POI	point of interconnection
PPA	power purchase agreement
PPI	power performance index
PPT	power performance testing
PR	performance ratio
PUCT	Public Utilities Commission of Texas
PV	Photovoltaic
PWM	pulse-width modulation
QA/QC	quality assurance/quality control
RoCoF	rate of change of frequency
SCADA	supervisory control and data acquisition
SCIG	squirrel cage induction generator

---

SCR	short-circuit ratio
SIR	synchronous inertial response
SSR	sub-synchronous resonance
SSI	sub-synchronous Interaction
SVC	static VAR (volt-ampere reactive) compensator
THD	total harmonic distortion
TSO	transmission system operator
VAR	volt-ampere reactive
VRE	variable renewable energy
W	watt
WTG	wind turbine generator
WTGS	wind turbine generating system

**All dollar figures denote U.S. dollars unless otherwise noted**

---

# TECHNICAL GUIDES ON VRE GRID INTEGRATION: PREFACE

Over the past ten years, the cost of technology for variable renewable energy (VRE) such as wind and solar energy, has declined considerably, providing a cost-effective and sustainable means of meeting electricity demand in developing and middle-income countries. Taking advantage of variable sources of energy requires significant expansion and modernization of electrical grids and implementation of VRE-specific technologies, processes and requirements to gradually transition power systems into “VRE-friendly” grids that will significantly reduce integration costs in the long term. The need for technical assistance on VRE integration is greatest in countries with limited capacity to tackle technical and regulatory challenges. To meet this growing demand, the Energy Sector Management Assistance Program (ESMAP) of the World Bank has prepared a set of technical guides that can help World Bank staff and clients understand some of the essential requirements and available technical and regulatory measures to integrate large shares of VRE into power grids without compromising the adequacy, reliability or affordability of electricity. The technical guides have been developed as a joint initiative between ESMAP’s Variable Renewable Energy (VRE) Grid Integration Support Program and the Global Sustainable Electricity Partnership (GSEP). The Global Sustainable Electricity Partnership is a not-for-profit international organization comprising the leading companies in the global electricity sector who promote sustainable energy development through electricity sector projects and human capacity-building activities in developing nations worldwide.

It is projected for the next five years that annual worldwide addition of solar and wind energy will continue to grow and is likely to at least double compared to their current share in power systems. Modern renewable energy generation technologies provide a strong alternative for grid electrification in locations where renewable resources are abundant and are starting to become the least-cost option in many of the client countries thanks to rapid decline in prices. For this, many emerging economies have started to adopt policies to encourage the development of the industry to realize the benefits that renewable power generation can have for their energy supply and on the local environment. Solar and wind installations can be built relatively quickly, which presents a major incentive in rapidly-growing, emerging markets with urgent need for power and also tackle the realization of climate change commitments.

The key challenging issue, however, is the intermittent nature of solar and wind power, which increases the complexity of overall grid operations. The grid operators have to manage variability of the energy resource, reliability of grid operations and least-cost optimal performance. The fast penetration of renewable energy, and especially, a high level of their penetration into the power grid requires an adapted power system planning, better forecasting methods, introduces challenges in grid management, imposes stringent requirements for VRE integration into the grid, and necessitates standardization and structured process for the conducting studies to ensure compliance with the grid code requirements. The basic grid support services are becoming now relevant to all generators, including VREs, which are connected to medium and lower voltage levels. The modern electricity industry is restructuring with two major trends: significant increase of renewable energy and deregulation providing consumers with energy purchasing options of highly reliable delivery. However, deregulation, open energy access, and cogeneration are creating scenarios of transmission congestion and forced outages. Restructuring envisions the transmission grid as flexible, reliable, and open to all exchanges no matter where the suppliers and consumers of energy are located. The modernization of the grid requires the increased power quality, system stability, and increased transfer capacity of the

---

transmission. New approaches to Power System Operation and Control are gaining the development momentum for overload relief and efficient and reliable operation. High-voltage direct current (HVDC) and Flexible Alternating Current Transmissions Systems (FACTS) technologies appear especially effective for improvement of grid operations and management.

The proliferation of smarter infrastructure, enabling participation of increasing amounts of demand in activities also help mitigate the variability of renewable generation along with technological advances of renewable and complementary technologies like batteries allow renewable generators themselves to effectively contribute to maintaining reliability. A variety of emerging end-use technologies like electrical vehicles, heat pumps, and smart and efficient buildings enable greater flexibility in power systems and lead to higher demand for wind and solar. These technologies help to enable even greater usage of VRE resources, but at the same time, they bring additional challenges of overall grid operations, which require new approaches to system operation and planning to ensure that the new trends contribute to clean, reliable and affordable power systems. A shorter dispatch cycles in combination with more accurate shorter-term forecasts of renewable generation can be used to reduce forecast variations from renewable generators and result in reduced ancillary service requirement. A look-ahead unit commitment and stochastic unit commitment can effectively deal with uncertainty. Wind farm can be tasked to provide frequency response, inertial response, and regulation if they meet eligibility requirements. Storage technologies are beginning to be gradually deployed or included in provision of ancillary services. Frequency regulation market, which awards quick-start and fast responding resources including batteries, has been attracting an increasing amount of battery storage and new ways of using storage. There are also ongoing innovations combining variable renewable production with measures aiming to make demand more responsive. The benefits and effectiveness of new emerging trends are well recognized, but there are yet to reach full maturity and become standardized. The focus of the technical guides is primarily on the industry proven technologies and methodologies, which have already been established, widely adopted, and continue to proliferate in electrical utilities. However, the discussion of some new VRE related technologies that have already started influencing the utility landscape (e.g. dynamic energy storage, implementation of superconducting materials in fault current limiting devices, advanced forecasting methodologies, wind farm synthetic inertia and regulation response) are selectively included in the technical guide material where appropriate.

The information presented in the technical guides is compiled from various sources of information to serve as a high-level guidance and quick reference for the World Bank personnel on electrical power system projects involving implementation of VRE along with associated technologies and analysis. The technical guides are comprised of the following four sets of sub-documents, which are identified as the subjects of prime technical interest for VRE implementation:

- Grid Integration Requirements for Variable Renewable Energy
- Compensation Devices to Support Grid Integration of Variable Renewable Energy
- Studies for Grid Connection of Variable Renewable Energy Generation Plants
- Using Forecasting Systems to Reduce Cost and Improve the Dispatch of Variable Renewable Energy

---

**“Grid Integration Requirements for Variable Renewable Energy”** document presents a general overview of VRE technology along with some recommendations for VRE technical specifications, applicable standards, and essential testing. The main focus of the document presents a detailed outline of the essential requirements of VRE power plants integration into power grid. The different levels of VRE penetration in the grid determine different technical requirements for VRE integration. However, some of the requirements are fundamental and need to be respected for a VRE integration in any power system, e.g. regulation and automatic response to grid events, power quality, protection system, forecasting and analysis. The basic and advanced VRE integration requirements are discussed in detail in this document in order to provide a guiding reference for VRE projects regardless of the grid code’s maturity. All essential requirements in the grid are summarized in the checklist table and can be used in course of VRE’s project planning, implementation, and connection to the grid. The compliance with the technical requirements and grid code where applicable is validated through extensive series of interconnection studies such as steady state analysis, short-circuit and circuit breaker duty review, dynamic stability, and facility studies.

**“Compensation Devices to Support Grid Integration of Variable Renewable Energy”** document provides an overview of FACTS and other compensation devices along with the essential characteristics describing industry need, applicable standards, functionality, applications, and recommendations for minimal technical specification. The main objective of the document is to discuss all available FACTS technologies with the underlying concept of independent control of active and reactive power flows, the essential differences and benefits of FACTS devices, and industry applications. Classification and comparison of performance factors are analyzed in detail and summarized to orient the reader in the wide spectrum of FACTS devices, and their effects on the power system. The applications of FACTS devices are associated with the following essential technical enhancements: System Capacity, System Reliability, Power Quality, System Controllability. Environmental benefits of FACTS are obtained through the deferral of the construction of much more expensive transmission lines and better utilization of existing system assets.

**“Studies for Grid Connection of Variable Renewable Energy Generation Plants”** discusses the power system studies requirements for the stable grid integration of renewable energy plants. These requirements differ depending on the size of generation, the location of the connection, and whether it is transmission or distribution system. The main purpose of screening studies involved in the interconnection process is a successful integration of the VRE into the grid. Power system planning for interconnection of new variable generation resources ensures that there are sufficient energy resources and evacuation capacity to interconnect new supply, and that demand requirements are met in a reliable and efficient manner. Also, the studies verify that adequate reserves and necessary system resources exist to reliably serve demand under credible contingencies such as the loss of a generating unit, a transformer, or a transmission facility.

**“Using Forecasting Systems to Reduce Cost and Improve the Dispatch of Variable Renewable Energy”** document discusses the need and benefit of forecasting capabilities and how it is becoming more relevant to both system operators and large-scale VRE generators. Forecasting solar or wind generation over a timeframe of days, hours and minutes before real time power system operations can reduce balancing costs, minimize VRE curtailment levels, improve system reliability and ultimately increase the penetration of VRE sources in the energy mix. The main objective is to focus primarily on the types of forecasting methods and how physical and statistical models are used for developing short- to long-term forecasts. Good forecast helps to reduce the gap between contracted supply of power and actual provision of power, reducing imbalance costs for the generator. Essentially, an effective forecasting system helps move the entire power system closer to a fully merit-order dispatch system, with reduced uncertainty and costs around variable generation supply. Technological advances in weather

---

forecasting, which, together with better data on historical performance of renewable energy, allow significantly improved forecasting accuracy of renewable generation, which results in a more efficient utilization of VRE.

---

# ACKNOWLEDGEMENTS

The Technical Guides on VRE grid integration is a joint initiative by the Energy Sector Management Assistance Program (ESMAP) of the World Bank and the Global Sustainable Electricity Partnership (GSEP). GSEP is a not-for-profit international organization made up of the leading companies in the global electricity sector that promotes sustainable energy development through electricity sector projects and capacity-building activities in developing countries.

This Technical Guide is part of ESMAP’s variable renewable energy (VRE) grid integration support program. This global program helps World Bank client countries achieve the cost-effective and sustainable scale-up of VRE by providing technical assistance, capacity building, and knowledge products for the development and implementation of planning, regulatory, market, and operational best practices in VRE integration.

The document on “Grid Integration Requirements for Variable Renewable Energy” was authored by a team comprising [Silvia Martinez Romero](#) (Task Team Leader and Senior Energy Specialist, ESMAP), [Chong Suk Song](#) (Energy Specialist, ESMAP), [Martin Schroeder](#) (Former Energy Specialist, ESMAP), [Kiamran Radjabli](#) (Consultant, World Bank) and external experts [Paulo Cesar Fernandez](#) (Electrobras); [Noel Aubut](#) (Hydro-Québec), [Pascal Prud’Homme](#) (Hydro-Québec), [Sylvain Bastien](#) (Hydro-Québec), [Alessandro De Cristofaro](#) (Enel) and [Gaetano Marletta](#) (Enel).

The team is grateful to the Secretariat and its members, especially Hydro-Québec and Enel Green Power, for their contributions on the first draft of this guide. [Slavica Antic](#) (Hydro-Québec) and [Luis Calzado](#) (Senior Project Advisor at GSEP) provided important insights and recommendations.

The team also wishes to thank peer reviewers [Rabin Shrestha](#) (Senior Energy Specialist, World Bank) and [Xavier Remi Daudey](#) (Consultant, World Bank) who provided valuable comments and constructive insights at various stages of this work, including in the Decision Meeting, chaired by [Rohit Khanna](#) (Practice Manager, ESMAP). Highly valued comments were also provided by [Surbhi Goyal](#) (Senior Energy Specialist, World Bank) and [Amit Jain](#) (Senior Energy Specialist, World Bank).

---

# EXECUTIVE SUMMARY

Modern renewable power generation technologies are becoming very cost-effective, and thus increasingly attractive as an alternative for grid electrification in locations where renewable resources are available. Many emerging economies have excellent renewable energy resources and have adopted policies to encourage the development of the industry to realize the benefits that renewable power generation can have for their energy supply and on the local environment. Renewable energy resources for electricity generation encompass hydro power, geothermal power, and biomass power as well as “intermittent” or “variable” renewable energy (VRE) sources such as wave and tidal power, wind power, solar photovoltaics, and concentrating solar power.

The focus of this technical guide is on VRE, which is a non-dispatchable energy resource due to its fluctuation depending on the season and time of the day.<sup>1</sup> Unlike other forms of renewable energy, VRE cannot be stored or increased/decreased other than when nature provides. Solar and wind power are the most prevalent and industrially proven VREs on the market, and their construction and operations have yielded substantial benefits in terms of inexpensive power and low environmental impact. Also, solar and wind installations can be built relatively quickly, often in 6–12 months, depending on the size of the power plant – which presents a major incentive in rapidly-growing, emerging economies with an urgent need for power. However, the increased VRE generation has made it more difficult for grid operators to manage the variability of the energy resource while maintaining grid reliability and optimizing grid performance, grid stability, and quality of power supply.

Renewable power generation technologies currently account for about half of all new power-generation capacity added worldwide. The rapid deployment of renewable technologies has had a significant impact on cost reduction, particularly for solar, and to some extent, wind energy. Assuming that PV and wind technology prices continue to decline relative to competing sources of electricity, the market penetration rate of utility-scale renewable energy projects is likely to continue its uptrend worldwide. The advent of energy storage technologies elevates even further the potential of VREs and their role in the future of energy market.

The large penetration of renewable energy into the power grid introduces challenges in grid operation and management, imposes stringent requirements for VRE integration into the grid, and necessitates better understanding of the VRE technologies requiring an adapted power-system planning approach to incorporate the variability of VRE sources. It may also result in electrical industry changes such as new requirements for functionality and performance of the renewable energy power plants, the need for specific and detailed technical specifications, a higher level of standardization, and improved grid connections to evacuate energy from the plant.

It is important to have an electrical grid code for optimal implementation, connection to the grid, and operation of VRE generation. However, it is also reasonable to analyze requirements for connecting VRE generation to the grid in countries where the grid code is still being developed or is not yet fully established for operations. The system requirements imposed on VRE generation depend on the existing and planned share of VRE in the generation pool for the entire power system. Because the VRE share in the pool continues to rise, VRE plants are having to take over an increasing number of responsibilities

---

<sup>1</sup> The *dispatchability* of an electricity generation source refers to the source’s ability to be controlled in response to the power system requirements of meeting load demand.

---

from the conventional generators they replace. The basic grid-support services are now becoming relevant to all generators, including VREs, which are often connected at lower voltage levels.

The different levels of VRE penetration in the grid also determine different technical requirements for VRE integration. However, some of the requirements are fundamental and need to be respected for a VRE integration into any power system – for example, regulation and automatic response to grid events, power quality, protection system, forecasting and analysis. The basic and advanced VRE integration requirements are discussed in detail in this document in order to provide a guiding reference for VRE projects regardless of the grid code’s maturity. All essential requirements for the grid are summarized in a checklist table (see TABLE 4.1: Checklist of Essential Requirements for VRE Grid Integration) and can be used in the course of VRE project planning, implementation, and connection to the grid. Compliance with technical requirements and (where applicable) grid codes is validated through an extensive series of interconnection studies such as steady-state analysis, short-circuit and breaker-duty review, dynamic stability analysis, and facility studies.

This document also discusses VRE technology in general and makes recommendations for VRE technical specifications, applicable standards, and essential testing. The presented information has been compiled from various sources of information to serve as a high-level technical guide for World Bank personnel involved with electrical power system projects.

This technical guide frequently refers to vendor-specific offerings to help the reader comprehend the grid integration requirements for VREs. However, these references are by no means comprehensive. Rather, they are intended only as a starting point for the reader to gain an appreciation of the general subject. The inclusion of references to particular products is not intended to reflect their importance. The World Bank does not endorse individual vendors, products or services. Therefore, any reference herein to any vendor, product or services by trade name, trademark, or manufacturer or otherwise does not constitute or imply the endorsement, recommendation or approval of the World Bank.



---

# 1 | INTRODUCTION

The term *variable generation* generally refers to generating technologies whose power output varies over time and cannot reasonably be controlled to address such variation. These variable-generation sources – which include wind, solar, ocean and some hydro – are all renewable-based. There are two major attributes of this variable renewable energy (VRE) that distinguish it from conventional forms of generation and may affect planning and operations for bulk power systems: the variability and a higher degree of uncertainty.

This technical guide will focus on “utility-scale” – i.e., generally over 5 megawatts (MW) – implementations of solar photovoltaic (PV) and wind energy power plants in the bulk power system. Small PV and wind turbines connected at distribution levels, such as residential and small commercial installations, are out of the scope of this document. That said, we do recognize that there has been a substantial rise in the deployment of small, distribution-connected variable generation in many countries, and that this must also be regulated as it, too, has the potential to impacting grid performance. Distributed variable generation in the grid is an important subject that certainly deserves a thorough (but separate) discussion.

The increasing size of global renewable markets and the diversity of suppliers have resulted in more-competitive markets for renewable technologies. The penetration of VRE usually brings with its environmental benefits involving the reduction of CO<sub>2</sub> emissions from the electric sector. Solar photovoltaic (PV) technology – with an installed capacity greater than 386 gigawatts (GW) worldwide in 2017, and a record annual addition of about 94 GW in 2017 (substantially higher than the average 40 GW additions in previous years) – has become an increasingly important energy supply option as a substantial decline in the total cost of solar PV power plants has improved its competitiveness with other power generation options.<sup>2</sup> Wind energy has also been growing at a fairly steady pace of about 50 GW each year, reaching a total installed capacity of 514 GW in 2017 (IRENA 2018). The International Renewable Energy Agency (IRENA) (New Energy Update 2017) and the Global Wind Energy Council (GWEC) (GWEC 2017) have each projected that annual worldwide installations will continue to grow at about 90GW/year for solar and more than 60 GW/year over the next five years.

Conceptually, modern VRE generation sources differ significantly from traditional energy sources in terms of behavior during network faults, impacts on power quality, and response to frequency changes. As a consequence, grid codes have recently established new rules for VRE technical connections that often must be implemented not only by individual generators, but through a system approach (Ackermann et al. 2016). For immature grid codes or codes under development, the VRE connection still requires a technical analysis, an evaluation of connection viability, and possibly implementation of supporting means to address the fluctuating nature of the generated power from the standpoint of system reliability, performance, and power quality.

This technical guide is divided into three main sections. Following this introduction, Section 2 provides an overview of solar and wind power technologies, describing their essential functionality and recommending technical specifications and requirements for VRE plants. Section 3 contains a detailed analysis of VRE power plant integration into power grids, focusing on power-system planning for

---

<sup>2</sup> The *total cost* takes into consideration a combination of equipment cost, installed project cost, fixed and variable operating and maintenance costs.

---

interconnection of new generation resources. Section 4 concludes by presenting a checklist of essential requirements for VRE grid integration. Thereafter, Appendix A lists a variety of applicable standards for VRE power plant implementations, and Appendix B recommends additional functionalities and requirements that can be useful for in-depth analysis of solar and wind power grid integration. Finally, a full reference list can be found at the end of the document.

---

## 2 | VRE POWER PLANTS

This section presents an overview of existing implementations of solar photovoltaic (PV) and wind energy power plants in the bulk power system. The focus is on utility-scale plants with a capacity of more than 5 megawatts (MW). Although there has been a substantial rise in the deployment of small, distribution-connected variable generation in many countries, this is outside the scope of the present document.

### SOLAR POWER

Solar generation consists of two broad technologies: solar thermal and solar PV. The focus of this document is on the PV system for utility-scale power plants as it is the prevailing technology for many modern power plant implementations. The International Electrotechnical Commission’s (IEC) 61836 standard defines solar PV as an “assembly of components that produce and supply electricity by the conversion of solar energy. Solar PV converts the electromagnetic radiation in sunlight directly into direct current (DC). PV can use both diffuse solar radiation and direct normal irradiance (DNI). The power produced depends on the material involved and the intensity of the solar radiation incident on the cell. In order to interconnect with the AC power system, a PV system must use a power electronic inverter to convert its DC output at the terminals of the PV panel into AC.”

#### *Photovoltaic Generation Technology*

The distinguishing feature of PV generation technology is solar modules that convert electromagnetic radiation received directly from the sun into useful electricity. In addition to solar modules, PV systems contain a large amount of supporting equipment, which serves to balance the system and to make it sustainably operational. The extra components – including wiring, controllers, energy storage devices, trackers, mounting hardware, inverters, and grid connections – may vary depending on the scale and application. PV systems are typically modular in design, so that additional sections can be added to the plant or removed for repairs without significantly disrupting its infrastructure.

The main components of a PV power plant are a transformer, a DC/AC inverter, a charge regulator, and PV modules (see FIGURE 2.1). Although PV plants do not traditionally have an energy storage system as part of their basic design, some utilities have begun incorporating battery energy storage into PV plant design to support the generation output. In these cases, the consideration of energy storage is integrated into the relevant power purchase agreement.

**FIGURE 2.1: Solar PV Plant Main Components**

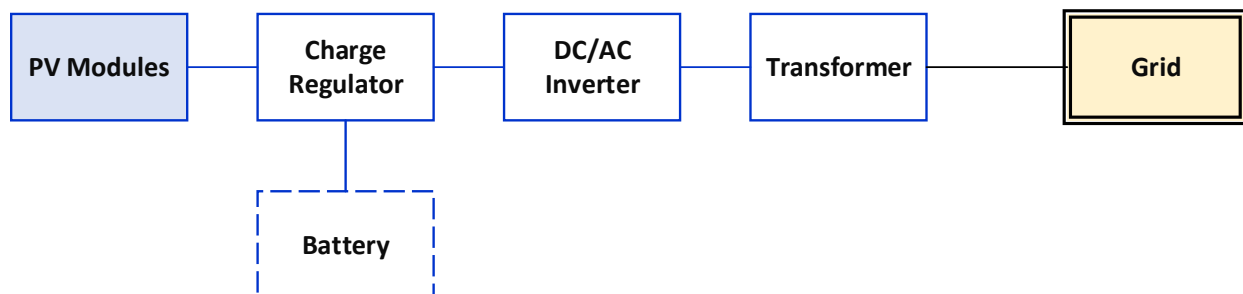

---

## Charge Regulator

The charge controller, or regulator, manages the flow of electricity between the solar module arrays, energy storage, and loads. The appropriate charge-control algorithm and charging currents need to be matched to the batteries (or other energy storage devices) used in the system. The charge controller protects batteries from damage. Typically, the regulator operates in switch-on/off mode, and the hysteresis cycle protects the battery from overcharging and excessive discharging. Charge controllers also help with voltage conversion and maximum-power tracking.

## Batteries

Batteries are used in PV systems to supply power at night and during periods of low irradiance. Additionally, batteries are required in solar PV systems because of the fluctuating nature of the PV output.

Battery size/capacity is selected according to the plant size, the battery's capability to sufficiently absorb high resource fluctuations, and the need to reduce curtailment losses.<sup>3</sup> Batteries are usually connected in parallel to match higher capacity.

There are several types of batteries commercially available for solar applications, including lead-acid, nickel-cadmium, nickel hydride, and lithium. The main design criteria for batteries used as energy storage for solar systems are that they must be able to go through deep charging and discharging cycles without too much degradation or guarantee a certain lifetime required.

Batteries are classified by *nominal capacity*, which is the maximum amount of energy – in ampere-hours, from which the megawatt-hours (MWh) can be derived – the battery can sustainably produce under standard conditions.

## Photovoltaic Inverter

At the heart of every PV plant is the PV inverter, which converts the DC power coming from the solar modules into AC power destined for the grid. The inverter is a key component in both grid-connected and distributed-power applications and usually represents a significant part of the system cost. Inverters can convert DC power from either batteries or solar modules into 60 or 50 Hz AC power. As with all power system components, the use of inverters results in certain energy losses due to conversion; the typical efficiency of an inverter well matched to the array is around 90 percent. The inverter enclosures are grounded for safety reasons according to grid code requirements.

Currently various types of PV inverter are available on the market, and the devices are classified on the basis of three important characteristics: power output, module wiring, and circuit topology.

- 1) The available *power output* starts at two kilowatts (kW) and extends into the megawatt range. Typical outputs are 5 kW for private home rooftop plants, 10–20 kW for commercial plants (e.g. factories or barn roofs) and 500–800 kW for use in PV power stations or farm sites.
- 2) For *module wiring* (or “erection topology”), distinctions are made between string, multistring and central inverters, whereby the term “string” refers to a string of modules connected in series. Multistring inverters have two or more string inputs, each with its own maximum power point tracker (MPPT).

---

<sup>3</sup> *The need to reduce curtailment losses* refers to a situation where the power output from the renewable power generation project exceeds the regulated level, and the plant is required to temporarily shut down to avoid financial penalties.

- 
- 3) With regard to *circuit topology*, distinctions are made between one- and three-phase inverters, and between devices with and without transformers. Single-phase inverters are usually used in small plants up to 5–10 kW. Large utility-scale PV plants use either three-phase inverters or a network comprising several single-phase inverters. The three-phase inverter, which distributes the solar power evenly across all three phases, consists of a DC bus and three pairs of electronic power switches.

The inverters have the following important features:

- 1) *Low-loss conversion*, the essential characteristic of an inverter, determines conversion efficiency, which is usually around 98 percent.
- 2) *Maximum power point tracking (MPPT)* is essential characteristic for defining the energy output of a PV plant. The power characteristic curve of a PV module strongly depends on the radiation intensity and temperature at which the module operates. The optimal operating point is called the "maximum power point" (MPP), and the search for, and tracking of, such MPP is correspondingly called "MPP tracking". Central inverters only have one MPP tracker despite a relatively higher power output. They are especially well-suited for large-scale plants with a central inverter approach.
- 3) *Grid code compliancy* include low-voltage ride-through (LVRT), reactive power control, and frequency and voltage control, all in compliance with the most advanced standards.

The inverter usually employs power-electronics technology based on insulated-gate bipolar transistors (IGBT), with pulse-width modulation (PWM) for the modulation technique. The technology has protection logic for short-circuit, over-temperature, DC overvoltage and AC over-/undervoltage, and AC over/under-frequency conditions. For large-scale applications, three-phase inverters are normally used.

The following are the main electrical characteristics of the AC side of the inverter:

- 1) Nominal voltage
- 2) Operating frequency 50 or 60 Hz
- 3) AC output voltage
- 4) Power factor >0.9
- 5) Maximum current imbalance  $\leq 2$  percent
- 6) Total harmonic distortion (THD)  $\leq 3$  percent
- 7) European efficiency<sup>4</sup> 98 percent
- 8) Maximum efficiency 98 percent
- 9) Static MPPT efficiency 99.8 percent
- 10) Dynamic MPPT efficiency 99 percent
- 11) Output waveform: sinusoidal

The inverters must be protected against overloads and short circuits through devices installed on board the unit that can be easily handled by the operator. The contribution to the short-circuit current must be limited to a value of  $I_{cc} < 4I_n$ , where  $I_n$  is nominal current.

On the AC side, the inverter has to be equipped with a sectioning circuit breaker (in accordance with IEC standard 60947-2) and a disconnecting switch. On the DC side, the inverter has to be equipped with a circuit breaker for interrupting direct currents, with a sectioning function, as stipulated in IEC 60947.

---

<sup>4</sup> The "European efficiency" is an averaged operating efficiency during a year of power distribution corresponding to a middle-Europe climate.

---

Grid-tied inverters are used to “tie,” or connect, the PV system to the utility grid. They convert DC power to AC power in synchronization with the grid. For example, if grid fails for any reason, the inverter will shut down as well. The main considerations related to PV-grid interconnection are safety, power quality, and “anti-islanding.” *Islanding* occurs when the power grid shuts down and the inverter (one without an anti-islanding feature) attempts to power the grid using energy from the PV panels, which will continue to power the line as long as solar radiation is present. This can result in equipment damage and safety risks to technical personnel. To prevent this “island” mode of operation – i.e., a powered line in an un-powered grid – most of the modern AC grid-tied inverters have an “anti-islanding” feature, which can reduce power to zero less than 0.2 seconds after the grid shuts down.

Inverters are usually designed to comply with the requirements of each country’s grid code. At a minimum, the following features are generally required:

- 1) Tolerance of frequency and voltage deviations
- 2) Controlling of the active power production
- 3) Controlling of the reactive power production
- 4) Controlling of the power factor
- 5) Controlling of the voltage at the point of interconnection (POI)
- 6) Reactive power support during under- and over-voltage at the POI
- 7) A P-Q capability curve for leading and lagging power factor at POI to regulate voltage in the operational range required by the grid operator generally between 0.9-1.1 p.u. (see Figure 2.2 for some examples of P-Q capability curves)

FIGURE 2.2: Sample P-Q capability curves from different transmission operators in Europe

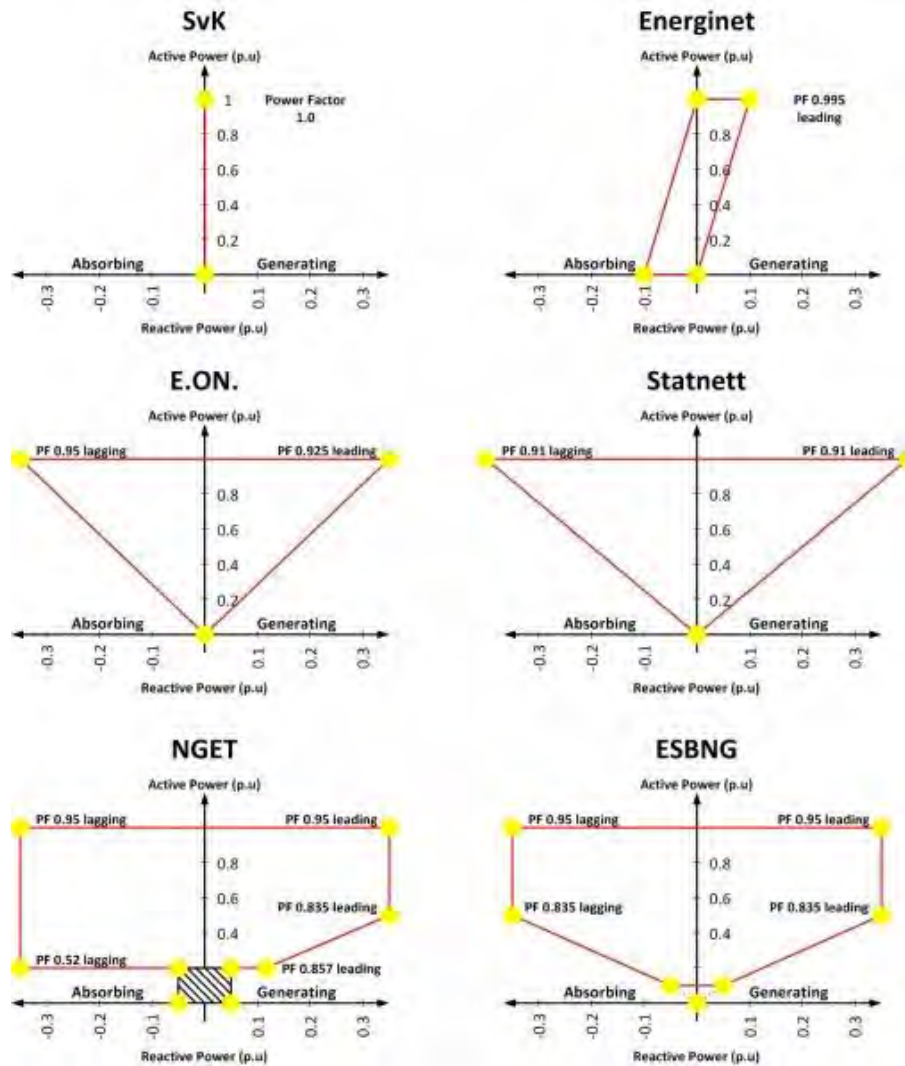

Source: © NERC, 2012. Used with the permission of NERC. Further permission required for reuse<sup>5</sup>.

The power quality and especially system harmonics of PV plants must be also strictly regulated. Filters and systems for reducing harmonic currents are often installed on both the AC and DC sides in order to (a) drastically reduce ripple voltage and (b) protecting grid components from the harmonic current flowing through them).

<sup>5</sup> This information from the North American Electric Reliability Corporation's website is the property of the North American Electric Reliability Corporation and is available at [https://www.nerc.com/pa/RAPA/ra/Reliability%20Assessments%20DL/2012\\_IVGTF\\_Task\\_1-3.pdf#search=integration%20requirements%20for%20variable%20generation](https://www.nerc.com/pa/RAPA/ra/Reliability%20Assessments%20DL/2012_IVGTF_Task_1-3.pdf#search=integration%20requirements%20for%20variable%20generation). This content may not be reproduced in whole or any part without the prior express written permission of the North American Electric Reliability Corporation.

---

The operation and maintenance (O&M) phase of a PV plant covers its operation for the expected lifetime of about 25 to 30 years. Usually PV plants do not require elaborate maintenance, but a damaged component has to be quickly repaired or replaced. Preventive and corrective maintenance, such as cleaning the panels, is required, and it represents a large share of the total O&M of a utility-scale PV plant.

### ***Essential Considerations for Technical Specification***

Large PV plants have the potential to provide fast ramping resources in a power system on demand. Under certain weather conditions, PV installations can change output by +/- 70 percent in a time frame of two to ten minutes, many times per day. Therefore, these plants should consider incorporating the ability to manage ramp rates and/or curtail power output.

The technical specifications for the construction and commissioning of solar power plants address many aspects of the contractor's work, including both civil and electrical works as well as equipment supply and installation. The following items are usually covered in the specification of a utility-scale PV plant (PacifiCorp 2016):

- 1) Contractor Responsibilities
  - a) Performance Characterization
  - b) Permitting
  - c) Construction and Installation
- 2) Site and Plant Description
- 3) Design and Engineering
  - a) Engineering Design Package
  - b) Site Layout, Maps, Line Drawings
  - c) Structural Engineering
  - d) Civil Engineering
  - e) Roads and Construction Access
  - f) Earthwork
  - g) Plant Design and State Requirements
  - h) Communication System
  - i) Security
- 4) Equipment
  - a) Equipment Supply
  - b) Signage and Labelling
  - c) Grounding and Bonding
  - d) Surge and Lightning Protection
  - e) Photovoltaic Modules
  - f) Step-Up Transformers
  - g) Inverters
  - h) Fixed Tilt Racking Structure
  - i) Single Axis Tracking Structure
  - j) Direct Current Fused Combiner Boxes
  - k) Meteorological Stations
  - l) Supervisory Control and Data Acquisition
  - m) Revenue Meter
  - n) Security Cameras and Related Equipment

- 
- o) Wire, Cable, and Connectors
  - p) Plant Switchgear
  - q) Emergency Direct Current Battery System
- 5) Warranties
    - a) General Contractor Warranty
    - b) Solar Module Warranty
    - c) Racking and Tracking System Warranty
    - d) Inverter Warranty
    - e) Transformer Warranty
    - f) SCADA Monitoring System and Security Equipment Warranty
    - g) Performance Warranty
  - 6) Applicable Codes and Standards
  - 7) Interconnection requirements (Grid Code Compliance)
  - 8) Operations and Maintenance — Manuals and Training
    - a) Documentation
    - b) Training
    - c) Maintenance Procedures
    - d) Operation Procedures
  - 9) Mechanical and Electrical Completion
  - 10) Synchronization Procedures and Requirements
  - 11) Procedure for Plant Acceptance
    - a) Quality Assurance/Quality Control
    - b) Commissioning and Startup
    - c) Interim Operating Period
    - d) Capacity Test Procedure
    - e) Substantial Completion
    - f) Final Completion

Out of this fairly comprehensive list, we will here elaborate on two key components of a solar plant that differentiate it from others: the photovoltaic modules and the inverter. However, it is recognized that there are other key components that must be specified in the bidding document. A list of important standards for the design, testing, and implementation of solar power plants is presented in Appendix A.

### *Photovoltaic Modules*

It is usually required in the specification that the PV modules meet specific standards that regulate the quality of the supply and functionality requirements. For example, it must be listed to UL standard 1703 for the voltage specified, as well as adhering to the requirements outlined in the following IEC standards:

- 1) IEC 61215 (“Crystalline silicon PV modules”) or IEC 61646 (“Thin-film terrestrial photovoltaic modules”)
- 2) IEC 61730, “Photovoltaic module safety qualification”
- 3) IEC 61701, “Salt mist corrosion testing of photovoltaic modules,” Severity 6

The specification usually requires the demonstration of a 25-year rated lifetime via long-term outdoor testing and/or accelerated-lifetime laboratory testing. Also, the supplier should be able to demonstrate manufacturing quality via electroluminescence (EL) testing of every module for defects.

The technical specification also usually requires a demonstration of the quality of supply and batch consistency; in this case, the vendor typically provides documentation that the batch of modules proposed for the project meets performance requirements. Several modules (e.g. 5–10, depending on the size of the plant scale) are tested to ensure performance and reliability under accelerated lifetime tests. Documentation may include flash test results and EL images before and after the tests, as shown in FIGURE 2.3.

**FIGURE 2.3: Module Manufacturing and Batch Quality Assurance Testing**

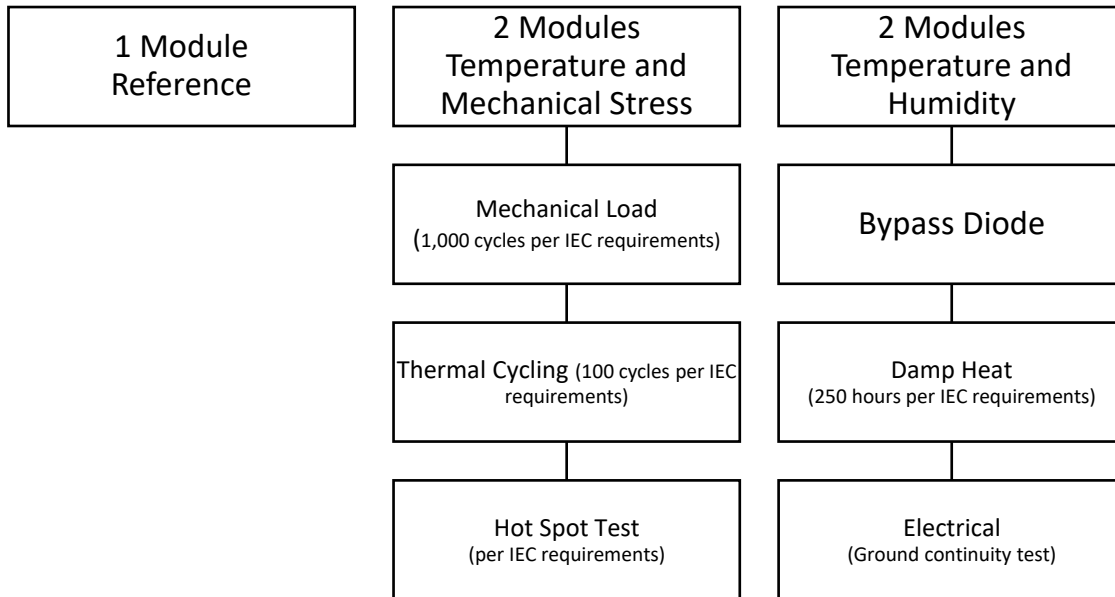

Solar flash tests (also known as “sun simulator tests”) measure the output performance of a solar PV module and are a standard testing procedure at manufacturers to ensure the conforming operability of each PV module. During a flash test the PV module is exposed to a short (1–30 ms), bright (100 MW per cm<sup>2</sup>) flash of light, usually from a xenon-filled arc lamp. EL imaging provides quality assessment and defect detection (e.g. micro-cracks, broken contact fingers) in solar cells and modules using high-resolution EL techniques. The module sampling, EL imaging, flash testing, and summary report must be properly documented and submitted to the project implementation team for review.

### *Inverter*

The inverter units must be calibrated so that the AC output, after inverter clipping and losses occurring between the inverter and the meter, does not exceed the plant’s AC capacity at the meter. The contractor usually supplies and installs inverters, transformer pads, and wiring/cabling to this equipment in accordance with the country code standard. The inverters are tied to an existing medium-voltage distribution system, connecting the system to the new generation facilities via medium-voltage transformers.

Inverters must comply with IEEE 1547-2003, including testing to IEEE 1547.1 and IEEE C62.45 standards. Regulatory standards compliance also includes IEEE C62.41.2 and CSA107.1-01.1. Inverters must have voltage and frequency ride-through functionalities, as well as be capable of actively regulating voltage levels by providing adjustable active and reactive power. The inverters/plant controllers must have the

---

capability of reducing their active power during certain predetermined conditions, which are usually specified in the interconnection agreement between the plant owner and electrical utility or market operator.

Inverters must also be in compliance with UL 1741, the “Standard for Inverters, Converters, Controllers and Interconnection System Equipment for Use with Distributed Energy Resources.”

It is important to stipulate at least the following requirements for inverters. They must:

- 1) Carry a minimum 5-year standard warranty with options for at least a 20-year extended warranty;
- 1) Be designed for a 30-year lifetime, assuming regular maintenance (including replacement of inverter components);
- 2) Have a maximum harmonic distortion less than 3 percent of total harmonic distortion at rated power output;
- 3) Have an efficiency greater than 97.5 percent without a medium-voltage step-up transformer.
- 4) Be capable of providing rated output at temperatures of 50°C or higher; and
- 5) Incorporate a no-load, two-pole, lockable disconnect switch or fusible disconnect for main DC power disconnect, for maintenance of personnel safety (DC load-break switches should be installed at the combiner boxes and at the inverters, located as close to the array as possible); and
- 6) Be equipped with lightning protection.

Inverters located outdoors must be enclosed in lockable enclosures and have coatings in accordance with Corrosion Protection codes. Any sensitive electronic equipment associated with, or part of, the inverter must be installed in a NEMA 4 rated enclosure.

The inverter output must be protected by a circuit breaker with short- and long-time adjustable over-current protection. This circuit breaker must be externally operated or an external on/off (start/stop) switch has to be provided. The inverter must include a fused and disconnectable control power transformer (CPT).

Inverters must employ an MPPT scheme to optimize inverter efficiency over the entire range of PV panel output for the given site design conditions.

Usually inverters are also equipped with the hardware required for data collection and communication to the central SCADA server and for direct external communication and controls, if communications to the transmission provider’s SCADA system is required by the interconnection agreement (IA) annexed to the power purchase agreement (PPA).

For some procurements, it may be admissible to explicitly stipulate that the inverter (a) has been supplied by a reputable or shortlisted equipment manufacturer regarded as either an original equipment manufacturer or a Tier 1 Supplier (i.e. a direct supplier to the original equipment manufacturer) and (b) has been certified to ISO 9001 and ISO 14001 standards.

### ***PV Power Plant Testing***

The testing of PV systems encompasses many electrical, mechanical, safety, and other test procedures which are based on verifying that both the individual components and the overall solar power plant are in compliance with known international standards. The comprehensive coverage of all PV plant components is beyond the scope of this document and is better addressed through an analysis of the applicable standards. The following topics have been selected because they constitute an important part of the design quality validation, performance testing, and safety of PV power plant implementation:

- 
- 1) PV modules design qualifications
  - 2) PV plant commissioning
  - 3) Capacity testing
  - 4) PV system AC performance

Each of these topics will now be discussed in turn; all four should be included in the checklist of PV power plant contract implementation.

### *PV Module Design Qualifications*

Solar panel warranties typically last about 25 years. PV modules need to be tested, however, to ensure they meet their warranted performance level. Design qualification testing using tests such as those given in IEC 61215 and IEC 61730 has been key for achieving high reliability of PV units. Additional standards – IEC 61646 and IEC 62108, along with new emerging standards – are also gaining momentum based on field observations and scientific investigations of observed equipment failures.

However, important new test proposals are current being developed that, although they have not yet become fully accepted standards, are nonetheless recommended as optional tests as they increase confidence in the durability and reliability of PV modules (NREL 2013):

- 1) *New or revised accelerated tests for components and modules*, including tests applying system-voltage bias, ultra-violet light, and mechanical stress.
- 2) *Revised sampling procedures*, including the requirement of random sampling from the production line. Although testing of engineering samples or modules that have been carefully selected from a manufacturing line gives an indication of the durability of a PV module design at its best, substantially greater confidence is obtained when the samples are selected randomly from the production line.
- 3) *Required audit of the quality management system* – for example, previous failure information incorporated into the requirements of the quality management system, product and manufacturing traceability, and incoming inspections of materials and subassemblies.

It is interesting to note that novel, automated PV testing procedures are emerging in the industry. On-field testing equipment has been developed with a portable SCADA tool based on DC and AC current and voltage sensors. Independent solar Global Horizontal Irradiation (GHI) delivers a data flow of PV array output that allows for the evaluation of overall PV system efficiency. The portable SCADA tool can collect testing data for many days and transfer the data automatically at a long distance.

Another promising method is the use of an autonomous video scan of PV modules from the air, done using unmanned aerial vehicles (commonly known as drones), which can be potentially very advantageous for large PV plants. The goal of such scanning could be to identify hotspots (i.e., indicating panels that, for some reason, are not working properly, or are completely turned off), or to provide the data to assess the effects of dirt on solar panel performance, or any other parameters that can be effectively assessed from the air.

### *PV Plant Commissioning*

The final, approved site acceptance test (SAT) and commissioning procedures for PV plants usually include the following (IEC 2009; Mokri and Cunningham 2014):

- 1) Safety plan during startup and commissioning
- 2) Review of all QA/QC testing on the DC and AC sides of inverters
- 3) Detailed procedure for plant startup, including switching sequencing

- 
- 4) Testing and energizing the inverters in conformance with manufacturer’s recommended procedures, noting operating voltages, and confirming the inverter is performing as expected
  - 5) Under full sun conditions, and after at least 15 minutes of operation, taking and recording plant operating data—such as but not limited to megawatts direct current ( $MW_{DC}$ ), megawatts alternating current ( $MW_{AC}$ ),  $V_{DC}$ ,  $V_{AC}$ ,  $I_{DC}$ ,  $I_{AC}$ , and solar radiation
  - 6) Testing the system control and monitoring system to verify that it is performing correctly
  - 7) Testing the communication system for offsite monitoring
  - 8) Testing the Plant metering and protective relaying to verify they meet utility requirements
  - 9) Detailed procedure for interface and initialization with the grid
  - 10) Documentation of successful startup and commissioning procedure

Upon successful completion of energizing and startup, the plant is considered operable. The process then moves to the Interim Operating Period, where the contractor makes the plant ready for capacity testing.

### *Capacity Testing*

The capacity test determines a PV power plant’s generation capacity or effective power rating. This test is often conducted prior to the plant’s commercial operation date, typically during system commissioning, and compares the facility’s expected capacity with its measured capacity. The capacity test is a critical step in the process of verifying that a PV system is properly designed and installed. Different approaches to capacity tests are outlined in standards published by ASTM International—including ASTM E2848, “Standard Test Method for Reporting Photovoltaic Non-Concentrator System Performance,” and ASTM E2939, “Standard Practice for Determining Reporting Conditions and Expected Capacity for Photovoltaic Non-Concentrator Systems”—as well as industry technical reports.

The capacity test is usually incorporated into project commissioning activities, and it can be performed over a period of days or weeks. The power generation of a PV system is documented by a capacity test that quantifies the power output of the system at set conditions, such as an irradiance of  $1,000 \text{ W/m}^2$ , an ambient temperature of  $20^\circ\text{C}$ , and a wind speed of  $1 \text{ m/s}$ . The capacity test represents only a short-term evaluation of power output, and a long-term test must be used to verify system performance under a range of conditions.

### *AC Performance Testing*

The IEC 62446 functionality tests and jurisdictional authorities define requirements for system safety and installation completeness and functionality. However, they do not verify whether the system’s power generation output meets requirements and design specification. The IEC standard does not call for an evaluation of power or long-term energy production over the range of weather conditions assumed in the original prediction. The AC performance evaluation is important because the Predicted Energy production output is used in the financial model to predict the long-term financial viability of the project through metrics such as return on investment (ROI) and levelized cost of electricity (LCOE).

The system AC performance test includes both an initial evaluation and an evaluation of the first twelve months of operation. The initial evaluation of power and energy is designed to ensure that the system is functioning properly. The extended evaluation compares the first full year of system actual Measured Energy production to the Expected Energy production based on actual weather conditions during the same year. Unlike a short-term performance ratio test or capacity test, which establishes the power rating of a PV system under very specific environmental conditions, a long-term energy test verifies PV system performance over the entire range of environmental conditions at a given site over a calendar year. An energy test can provide greater confidence that a PV system is installed and operating properly.

---

The following two metrics are commonly used to evaluate PV power plant performance:

- 1) *Performance ratio (PR)*, defined as the relationship between the actual and theoretical energy outputs of the PV plant. Commonly conducted during commissioning, the PR is a short-term test of the plant's efficiency in converting sunlight incident on the PV array into AC energy delivered to the utility grid. International standard IEC 61724, "Photovoltaic System Performance Monitoring—Guidelines for Measurement, Data Exchange and Analysis," published by the International Electrotechnical Commission, defines this performance metric.
- 2) *Energy yield (EY)*, which is annual production of electricity delivered at AC connection. An energy test is a long-term test designed to ensure that a PV system is functioning correctly across the full range of site conditions. A well-monitored energy test can provide good insight into overall PV system operations. When the performance guarantee requires an assessment of system performance under a range of conditions, a long-term energy test is appropriate. A one-year test period is useful for assessing all seasonal performance characteristics since it samples weather, shading and energy production associated with all seasons. While shorter test periods may integrate better with project schedules, they can result in higher uncertainty due to seasonal bias. This is especially true if the accuracy of the energy estimation model is inconsistent over the course of a year, such as when shading is incorrectly quantified.

Extended metrics for PV power plant performance may include two indexes:

- 1) The Power Performance Index (PPI), calculated as the actual Measured Power divided by the Expected Power; and
- 2) The Energy Performance Index (EPI), calculated as actual Measured Energy divided by the Expected Energy.

The PPI and EPI performance metrics are defined to use actual irradiance, temperature, wind speed, and as-built system configuration, all of which have an effect on the performance of the system. The details on the evaluation of the above metrics are provided in Cunningham, Hernday, and Mokri (2014) and in SMA Solar Technology AG (n.d.). The PPI and EPI acceptance criteria must be defined by the contract, e.g. 0.9 to 1.1 allowing a 10 percent tolerance. Although PR and EY are metrics commonly associated with PV plant performance, the PR metric does not account for cell temperature and wind speed, and EY does not account for cell temperature or irradiance. Therefore, the PR and EY metrics may not fully evaluate system function for PV plant commissioning, and a more elaborate measure of PPI and EPI performance can be considered a reasonably advanced replacement for the common PR and EY metrics.

The power/energy test results are usually compiled in a formal report that would include the following information items presented in various formats and structures:

- 1) The date and time of the test start and finish
- 2) A description of the test boundary and conditions under which conducted tests were conducted
- 3) Data validation documentation
- 4) A summary of test results
- 5) A comparison of test result parameters with project performance-guarantee conditions
- 6) Test result conclusions
- 7) Appendix containing:
  - a) Formal test procedure
  - b) Instrument cut sheets
  - c) Sensor calibration records

---

## WIND POWER

Wind power systems convert the movement of air into electricity by means of a rotating turbine and a generator. On- and offshore wind energy projects are now being built, including the commercial development of very large single wind turbines (up to 5 MW) and very large wind farms (up to several GW).

### ***Onshore and Offshore Generation Technology***

As wind speed increases, the amount of available energy increases, following a cubic function. Therefore, capacity factors rise rapidly as the average mean wind speed increases. A doubling of wind speed increases the power output of a wind turbine by a factor of eight. There is thus a significant incentive to site wind farms in areas with high average wind speeds. In addition, the wind generally blows more consistently at higher speeds at greater heights. For instance, a fivefold increase in the height of a wind turbine above the prevailing terrain can result in twice as much wind power. Air temperature also has an effect, as denser (colder) air provides more energy. The “smoothness” of the air is also important: turbulent air reduces output and can increase the loads on the structure and equipment, increasing materials fatigue, and hence O&M costs for turbines.

The maximum energy that can be harnessed by a wind turbine is roughly proportionally to the swept area of the rotor. Blade design and technology developments are one of the keys to increasing wind turbine capacity and output. By doubling the rotor diameter, the swept area and therefore power output are increased by a factor of four.

Shifting offshore brings not only the advantage of higher average mean wind speeds, but also the ability to build very large turbines with large rotor diameters. Although this trend is not confined to offshore, the size of wind turbines installed onshore has also continued to grow. The average wind turbine size is currently between 2 and 3 MW. Larger turbines provide greater efficiency and economy of scale, but they are also more complex to build, transport and deploy. An additional consideration is the cost, as wind towers are usually made of rolled steel plate. Rising commodity prices during the period 2006–08 drove increased wind power costs, with the price of steel tripling between 2005 and its peak in mid-2008.

### ***Wind Turbine Main Components***

A wind turbine is a complex piece of electromechanical equipment, and the design details of wind turbines are beyond the scope of this document. However, a general arrangement of wind turbine components (see also Schubel and Crossley 2012) is presented in FIGURE 2.4 (some of the components are mentioned in this document), and FIGURE 2.5 illustrates a typical onshore/offshore wind power plant connection.

**FIGURE 2.4: Wind Turbine Main Components**

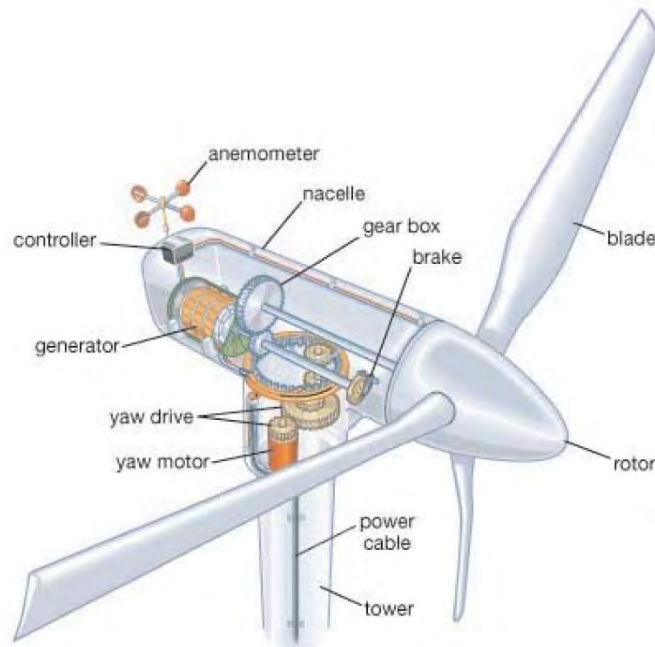

Source: © Simani, 2015. Used with the permission of Simani. Further permission required for reuse.

**FIGURE 2.5: Onshore and Offshore Wind Power Plant Connection**



Source: © Cigre, 2015. Used with the permission of Cigre. Further permission required for reuse.

### **Wind Turbine Generator Types**

Wind turbine generator (WTG) technology has evolved from Type 1 and 2 induction-based generators to Type 3 doubly-fed induction generators and Type 4 full-power, conversion-based generators. Because Type 1 and 2 generators consumed reactive power from the grid, they were not “grid-friendly,” and by and large they are no longer used in utility-scale turbines. By contrast, Type 3 and 4 WTGs are grid-friendly and can consume or produce reactive power to support grid functions. These turbines provide active and reactive power control, low-voltage ride-through (LVRT), and other features that can increase the stability and reliability of the grid. We will here discuss each of the four WTG types in turn.

#### **Types 1 and 2**

Generator Types 1 and 2 are based on early WTG technologies and represent the simplest types of modern wind turbines. Type 1 comprises a squirrel-cage induction generator (SCIG) driven through a gearbox. It can operate only within a very narrow speed range dictated by the speed-torque characteristics of the induction generator. It often uses passive stall (fixed pitch), which means that the wind turbine will stop by itself when the wind speed is too high to avoid any damage. Reactive

---

compensation is generally used to maintain the WTG power factor at unity since the induction generator consumes reactive power.

Type 2 is similar to type 1 in its design except that it is equipped with a wound-rotor induction generator. In addition, simple power electronics are used to control the rotor current and allow operation in a larger speed range ( $\pm 10$  percent), a feature known as “variable-slip” The Type 2 WTG is normally equipped with an active blade-pitch control system to limit the output power generated and the stress imposed on the mechanical components. Both types of wind turbine have limited performance capability. Additional equipment, such as a static VAR compensator (SVC) (ESMAP 2019a), is needed to enhance the fault ride-through capability and voltage-control support of the wind power plant.

### *Type 3*

The technical evolution of the previous designs led to the doubly-fed induction generator (DFIG) wind turbine, or so-called Type 3 wind turbine. The use of an electronic AC-DC-AC power converter connected between the wound rotor and the grid allows control of the magnitude and frequency of the rotor current; by allowing the wind turbine to operate at variable speeds, this optimizes power conversion from the wind. Only a fraction (typically 30 percent) of the power will flow through the power converter. In addition, fast and dynamic voltage control (i.e., reactive power control) can be performed for the Type 3 to the same degree as for conventional hydro or thermal power plants.

Because these turbines are decoupled from the grid, they naturally will not provide inertia to it. Pitch control is commonly used in Type 3 wind turbines to set aside some reserve power that can be delivered to the grid (on demand) to provide a degree of frequency control. FIGURE 2.6 shows the design of a Type 3 DFIG wind turbine. The main advantages of Type 3 generators are that decoupled control of active/reactive power is possible (i.e. they can be controlled separately) and they can support ancillary services (voltage/frequency regulation) through the convertor.<sup>6</sup> The main disadvantages are the limited fault ride-through and voltage regulation capability even though it is possible, regular maintenance requirements, large short circuit contribution, power system-turbine interactions that could result in sub-synchronous resonance issues<sup>7</sup> and damage that could result from improper synchronization requiring the need for compensation devices.

---

<sup>6</sup> The main difference between Type 3 and 4 is that Type 3 provides partial ancillary service support (through a converter that covers 30 percent of the rated power from the wind turbine) while the Type 4 provides more flexibility since its converter size is larger in capacity.

<sup>7</sup> *Sub-synchronous resonance* is a condition that can exist in the power system, especially for long distances, where the interaction between the power system and the wind turbines can result in power oscillations that can potentially damage equipment.

**FIGURE 2.6: Type 3 Wind Turbine Diagram**

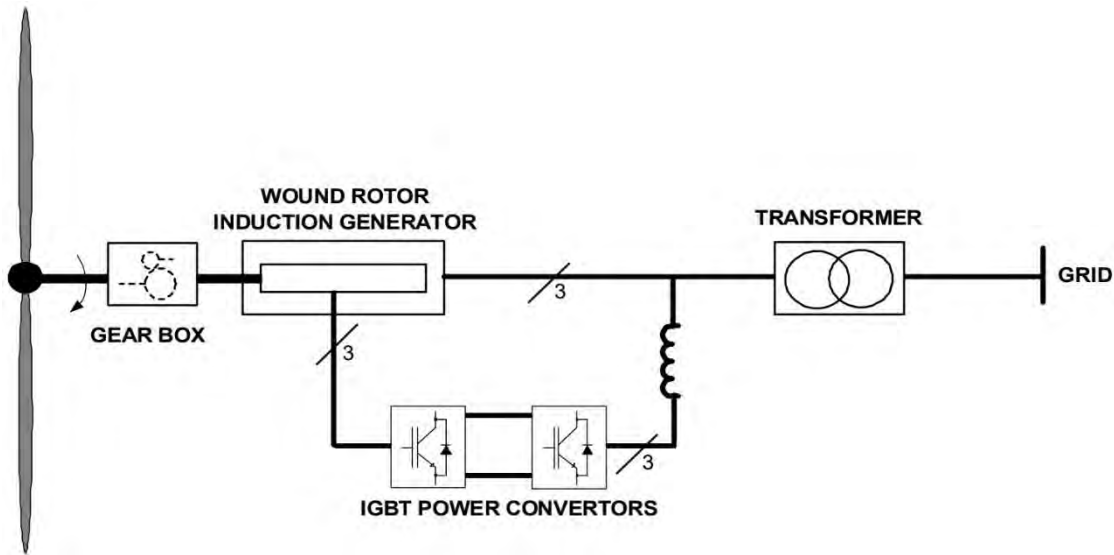

Source: © NERC, 2012. Used with the permission of NERC. Further permission required for reuse<sup>5</sup>.

#### *Type 4*

In Type 4 wind turbines, a full-power AC-DC-AC converter is used to connect the stator of the generator to the grid. Thus, all the power flows through the converter, allowing for large, variable-speed operation as well as reactive power and voltage control capability. Either asynchronous or synchronous generators may be used. There is a complete decoupling from the grid, and, similar to the Type 3 design, the response to grid frequency variation is not inherent to Type 4 wind turbines. Thus, the electric characteristics of Type 4 wind turbines are fairly similar to those of Type 3. One distinctive feature of the Type 4 is that the current may be electronically modulated to zero, thereby limiting the short-circuit contribution to the grid during large voltage disturbances. FIGURE 2.7 shows the design of a full-converter wind turbine (Type 4). The main advantage of the Type 4 generators is the maximum flexibility and reactive power capability – which derives from a fully controllable converter interface, lack of power system-wind turbine interactions, controllable short-circuit contribution, low-voltage ride-through capability, and lack of exposure to system faults. This type is more expensive than the Type 3 due its larger converter, which must accommodate the full rating of the wind turbine.

**FIGURE 2.7: Type 4 Wind Turbine Diagram**

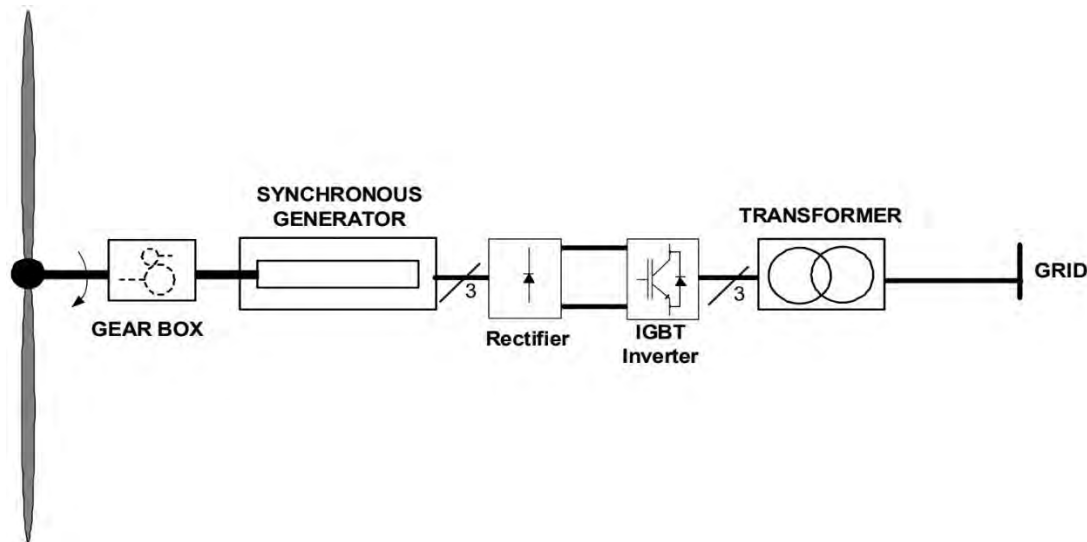

Source: © NERC, 2012. Used with the permission of NERC. Further permission required for reuse<sup>5</sup>.

### ***Essential Considerations for Technical Specification***

A key characteristic of wind power is its longer-term ramping attribute, which can be much different than its variability in the shorter term. In terms of short-term variability, there is considerable diversity in the output from wind turbines within a single wind plant, and an even larger diversity among wind plants dispersed over a wider geographic area. Such spatial variation in wind speed makes the combined output from many turbines significantly less variable than that of a single turbine. In fact, the aggregate energy output from wind plants spread over a reasonably large area tends to remain relatively constant on a minute-to-minute time frame, with changes in output tending to occur gradually over an hour or more. These longer-term changes are associated with wind ramping characteristics, which can present operating challenges.

Because of the rapid growth of variable generation and the resulting impacts on power system performance, variable generation must actively participate in maintaining system reliability along with their conventional generation. In combination with advanced forecasting techniques, it is now possible to design variable generators with a full range of performance capability that is comparable, and in some cases superior, to conventional synchronous generators.

The major functional control capabilities of modern wind turbine generation are as follows:

- 1) *Reactive support and power factor control* can be provided either through built-in capability (available for wind turbine generators Types 3 and 4) or through a combination of switched capacitor banks and/or power electronic transmission technologies such as SVC/STATCOM (applicable for all wind generator types).
- 2) *Voltage ride-through* can be achieved with all modern wind turbine generators, mainly by modifying the turbine generator controls. In some cases, with older Type 1 or 2 wind turbine-generators at weak short-circuit nodes in the transmission system, there may be a need for additional transmission equipment (subject to detailed studies).
- 3) *Power curtailment and ramping* can be achieved using a unit control mechanism for units with active-stall or pitch control, and/or discrete tripping of units.

- 
- 4) *Primary frequency regulation* can be supplied by all turbines that are equipped with some form of pitch regulation (i.e., active-stall or pitch control).
  - 5) *Inertial response* is inherent in Type 1 and 2 units and can be achieved through supplemental controls in the converter to emulate inertial behavior for Type 3 and 4 units.

Modern wind turbine generators can meet equivalent technical-performance requirements provided by conventional generation technologies with proper control strategies, system design, and implementation. Technical specifications for wind power plant construction and commissioning address many aspects of the contractor's work that include both civil and electrical works as well as supply and installation of equipment. The following list provides the items that are usually covered in the specification of a utility-scale wind power plant (PacifiCorp 2016):

- 1) Project Objectives and General Requirements
- 2) General Services
- 3) Project Site Conditions
- 4) Construction Management
- 5) Health, Safety, Security, and Environment
- 6) Project Schedule
- 7) Project Documentation
- 8) Signage
- 9) Permits
- 10) Training
- 11) Temporary Facilities
- 12) Logistics Services
- 13) Transportation and Delivery
- 14) Offloading
- 15) Coordination
- 16) Geotechnical Services
- 17) Field Investigations
- 18) Lab Testing
- 19) Civil and Structural Services
- 20) Site Preparation
- 21) Rock Excavation and Removal
- 22) Laydown Yard
- 23) Roads
- 24) Turbine Foundations and Turbine Pads
- 25) Other Site Works
- 26) Drainage and Erosion Control
- 27) Dust Control
- 28) Debris
- 29) Site Closeout and Restitution
- 30) Electrical Services
- 31) Collection System Circuits
- 32) Project Substation
- 33) Interconnection Line
- 34) SCADA System
- 35) Turbine Wiring
- 36) Interconnection Substation/Switchyard
- 37) Turbine Supply and Delivery

- 
- 38) Equipment Supply and Delivery
  - 39) Freewheeling
  - 40) Testing and Commissioning
  - 41) Turbine Erection
  - 42) Meteorological Towers
  - 43) Power Curve Testing
  - 44) Existing Meteorological Towers
  - 45) Permanent Meteorological Towers
  - 46) Temporary Meteorological Towers
  - 47) Maintenance Building
  - 48) Service and Maintenance

Out of this fairly comprehensive list, we will elaborate on only one key component of the wind plant that may differentiate the wind plant from other types of VRE: turbine supply and delivery.

### *Wind Turbine Specification*

The technical specification must stipulate that the contractor furnishes and delivers to the project site complete, fully-functional turbines to comprise the project capacity – including, but not limited to, the nacelle, blade set, hub tower, power converter, SCADA system, condition monitoring system, medium-voltage transformer (if nacelle-mounted), internal tower wiring and cabling, controllers, control panels, medium-voltage switchgear, anemometers, wind vanes, lightning protection devices, fall arrest system, rescue / emergency descent equipment, tower stairs, spare parts, appurtenances, consumables, and other similar items for each unit and other parts shipped loose (see FIGURE 2.4), which must conform to these component’s specifications. For large turbines and tall towers, it is recommended to have a climb-assist and/or service-lift system to facilitate turbine maintenance and regular inspections.

The technical specification for just the wind turbine may include the following possible subsections:

- 1) *Mechanical and structural components* – including rotor and blades, hub, gearbox, pitch system, lubrication system, yaw, bearing system, nacelle, tower, climb assist, and service lift;
- 2) *Main electrical components* – including generator, power converter, switchgear, tower wiring and cabling, obstruction lighting;
- 3) *Monitoring systems*, including condition monitoring system, meteorological equipment, and extreme weather packages (including equipment);
- 4) *Protection systems* – including lightning protection, corrosion protection, fire protection, emergency protection, and extreme weather package;
- 5) *Testing and quality control*; and
- 6) *Interconnection requirements* (grid compliance).

Certainly, all items in the above list are important to ensure reliable operation of the wind turbine. However, in the following we will briefly discuss only those items that are most relevant to this document’s focus, which is the VRE interconnection to the grid. The grid compliance of wind turbines is of utmost importance for successful operations of VRE in general, and wind turbines in particular, because modern turbines (type 3 and 4) can effectively contribute to grid regulation.

The generator type (e.g., induction or permanent-magnet) chosen for installation in the turbine can vary and largely depends on a combination of the manufacturer’s offering and the utility’s specific needs, such as the need to standardize with other turbines. Usually, the generator is a three-phase, variable-speed AC generator, with a rated frequency of 50 or 60 Hz and operating at the manufacturer’s standard voltage level.

---

The generator's rated power (generally between 1,000 and 4,000 kW) must take into account the project site's air density to ensure that the generator output will meet the specified energy requirement when installed at the particular location. The local air density is a very important factor in determining wind turbine performance and power output. A variety of factors – altitude above sea level, air temperature, humidity, and even barometric pressure due to local weather systems – can significantly affect local air density.

It is recommended to specify the generator's minimum protection class and insulation class for internal components (e.g., NEMA Class H insulation). The generator is usually enclosed in a weatherproof nacelle. The generator windings should be either copper or all-welded aluminum.

The technical specification must stipulate the comprehensive testing, commission, start-up, and placing into successful operation of all the power plant's turbines. At a minimum, the testing must include all requirements set forth in the applicable standards (see Appendix A) and all testing that is reasonably recommended or required by the applicable equipment suppliers, which includes collection system specifications and wind turbine specifications.

The technical specification usually stipulates that the contractor is responsible for start-up, testing, commissioning, and successful completion of commissioning of all turbines and other turbine equipment – including the SCADA system and service lifts (if applicable) – as well as all reliability tests.

A list of important standards for the design, testing, and implementation of wind power plants is enclosed in Appendix A.

### ***Wind Power Plant Testing***

The testing of wind energy systems encompasses many electrical, mechanical, safety, and other test procedures designed to verify that individual pieces of equipment as well as the overall wind power plant are in compliance with known international standards. The tests are performed at the component, turbine, and wind plant levels. There are roughly 8,000 component parts in a utility-scale wind turbine, including the blades, rotors, generator, or other parts located inside the nacelle. The comprehensive coverage of all wind turbine components and wind energy plant components is certainly beyond the scope of this document and is better addressed through analysis of the applicable standards. The following two topics have been selected for discussion here because they constitute an important part of the design-quality validation, long-term availability of the wind turbines, and performance of wind power plant implementation:

- 1) Commissioning and maintenance
- 2) Power performance testing (PPT)

These topics are discussed further below and should be included in the checklist of wind plant contract implementation.

### ***Commissioning and Maintenance***

Commissioning usually involves standard tests for the electrical infrastructure as well as the turbine, and inspection of routine civil engineering quality records. A wind turbine's "availability" (that is, the degree to which it is in a specified operable state) is a fairly important parameter, because if a turbine is subjected to maintenance and repairs, then the energy production from the wind plant maybe substantially reduced. The long-term availability of a commercial wind turbine is usually in excess of 97 percent, which is usually higher than that of a conventional power station. However, it may take a period of about six months for the wind farm to reach full, mature, commercial operation. During that

---

period of early operations, the availability will increase from about 80–90 percent immediately after commissioning to the long-term level of 97 percent or higher.

It is normal practice for wind farm suppliers to provide a warranty lasting between two and five years. This warranty will often cover lost revenue, including downtime to correct faults, and a test of the turbine’s power curve. For modern wind farms, there is rarely any problem in meeting the warranted power curves; in the early years of operation, however, availability can be lower than expected, particularly for new models. During the first year of operation some “teething” problems are usually experienced. For a new model, this effect is more pronounced. As model use increases, these problems are gradually resolved and availability rises.

After commissioning, the wind farm will be handed over to the operations and maintenance (O&M) crew. A typical crew will consist of two people for every 20 to 30 turbines in a wind farm. For smaller wind farms, there may not be a dedicated O&M crew, but some arrangements are usually made for regular visits and inspections from a regional team. Typical routine maintenance time for a modern wind turbine is 40 hours per year.

### *Power Performance Testing*

After a wind farm is built, the power performance of each wind turbine must be verified in accordance with international standards. The IEC has bundled together under the number 61400 several standards for different sectors of the wind energy industry. The following five of these standards are of significant importance (see Appendix A for a more comprehensive list of applicable wind power standards):

- 1) IEC 61400-1 Design Requirements
- 2) IEC 61400-2 Design Requirements of Small Wind Turbines
- 3) IEC 61400-3 Design Requirements for Offshore Wind Turbines
- 4) IEC 61400-11 Acoustic Noise Measurements Techniques
- 5) IEC 61400-12-1 Power Performance Measurements of Electricity Producing Wind Turbines

Overall, IEC 61400-12-1 encompasses the procedures for assessing the power performance of wind turbines, including measurement instrumentation and data analysis. IEC 61400-12-1:2005 specifies a procedure for measuring the power performance characteristics of a single wind turbine and applies it to the testing of wind turbines of all types and sizes connected to the electrical power network. It also describes a procedure to be used to determine the power performance characteristics of small wind turbines when connected to either the electric power network or a battery bank. New versions such as IEC 61400-12-2:2013 specify a procedure for verifying the power performance characteristics of a single electricity-producing, horizontal-axis wind turbine, which is not considered to be a small wind turbine per IEC 61400-2. This standard is intended to be used when the specific operational or contractual specifications may not comply with the requirements set forth in IEC 61400-12-1:2005.

The parameters that are taken into consideration for the assessment of the power curve of the wind turbine are the following:

- 1) Test site calibration
- 2) Test equipment
- 3) Measurement procedure
- 4) Derived results

This process of site calibration requires the installation of a meteorological mast, anemometers, wind direction sensors, and a data acquisition system along with a data logger. A site calibration may not always be required and is dependent on the complexity of the wind farm site in terms of topography. If a site calibration is required, it will involve the installation of two hub-height meteorological masts, one

near the wind turbine (the “turbine mast”) and the other at a reference location (the “reference mast”) a number of rotor diameters away from the turbine location and generally in the prevailing wind direction. These meteorological masts will measure wind speed and direction.

Test equipment is needed for carrying out the following measurements: electric power, wind speed, wind direction, air density, rotational speed and pitch angle, blade condition, and wind turbine control system. It is important for accurate and representative testing to ensure that all PPT equipment is properly calibrated and is documented in the test report. TABLE 2.1 shows a sample list of equipment used during typical PPT for Scaled Wind Farm Technology (SWiFT)<sup>8</sup> turbines of relatively small size connected to low voltage. (This is to simplify the example; large-scale wind turbines connected at medium voltage will have a more elaborate list of equipment.)

**TABLE 2.1: Sample of Test Equipment for PPT**

Instrument	Make and Model	Serial Number	Calibration Due Date
Power transducer	Secondwind Phaser 5FM-4A20		
Primary anemometer	Thies, First Class		
Reference anemometer	Met One, 010		
Wind vane	Met One, 020C with aluminum vane		
Pressure sensor	Vaisala, PTB101B		
Temperature sensor	Met One, T-200		
Precipitation sensor	Campbell Scientific, 237		
Data acquisition system	Compact DAQ w/LabView-based data acquisition cDAQ-9172 NI 9229 NI 9217 NI 9205		

Taking into consideration the information given in the standard, test technicians usually know the variables that must be measured, the sampling frequency for each type of measurement, the number of measurement points for each type of measurement, the type of statistical analysis to be applied to the collected data, and the type of data that must be rejected. In addition to specifying the reporting format, the standard defines clearly how the data must be normalized, how the power curve must be determined, how the annual energy production must be determined, and how the power coefficient must be determined.

Using the results of the site calibration phase, the actual testing will collect the required wind data and power output data from an independent power measurement panel (PMP) in the wind turbine; these data are then combined to create a power curve. This power curve can then be compared with the turbine manufacturer’s warranted power curve and any discrepancies reported and investigated further.

---

<sup>8</sup> The Scaled Wind Farm Technology (SWiFT) facility, located at Texas Tech University’s National Wind Institute Research Center in Lubbock, Texas, is the first public facility to use multiple wind turbines to measure turbine performance in a wind farm environment.

---

After completion of the power curve test, a full power-curve test report is prepared and the reference mast and PMP are decommissioned.

The following is a sample list of test result items for the SWiFT turbine:

- 1) Tabular:
  - a) Site assessment results, which may include maximum slope of best-fit plane less than threshold, maximum variation from best-fit plane less than threshold, lack of obstacles
  - b) Measured power curve. Performance at sea-level air density (reference air density in  $\text{kg/m}^3$ ) showing normalized wind speed in m/s, power output in kW, number of one-minute data sets, standard uncertainty
  - c) Measured power curve. Performance at site-average air density (reference air density in  $\text{kg/m}^3$ ) showing normalized wind speed in m/s, power output in kW, number of one-minute data sets, standard uncertainty
  - d) Estimated annual energy production (AEP) at sea-level air density (reference air density in  $\text{kg/m}^3$ ), showing annual average wind speed in m/s, AEP-measured in kWh, standard uncertainty in AEP-measured
  - e) Estimated annual energy production (AEP) at the site-average air density (reference air density in  $\text{kg/m}^3$ ), showing annual average wind speed in m/s, AEP-measured in kWh, standard uncertainty in AEP-measured
- 2) Graphical:
  - a) Power in kW, normalized to sea-level air density as a function of wind speed in m/s
  - b) Power in kW, normalized to the site-specific air density as a function of wind speed in m/s
  - c) Advanced additional plots – e.g., mean and standard deviation power data, coefficient of performance expressed (as a percentage) as a function of average wind speed in m/s and a function of wind direction in degrees; wind turbulence at the test site; rotor speed (in RPM) as a function of wind speed in meters per second; etc.
- 3) Photographic: Site photographs are usually included in test and inspection reports but are not mandatory if no structural issues or damages need to be reported.

---

# 3 | VRE INTEGRATION INTO THE POWER SYSTEM

## INTERCONNECTION OF RESOURCES

The main objective of power system operation is to keep the energy supplied in balance with electricity demand. On short time scales (from milliseconds to minutes), the objectives are power quality as well as voltage and frequency stability. On medium time scales (from minutes to hours), the scheduled production must meet the planned demand and the electricity produced needs to reach the load. On longer time scales (from weeks to seasons), the production and transmission capacity should be able to meet demand in all parts of the system over the whole year; otherwise, loads must be curtailed to keep the system in balance.

Power system planning for the interconnection of new generation resources ensures that there are sufficient energy resources and delivery capacity to interconnect new supply, and that demand requirements are met in a reliable and efficient manner for the planning horizon. In addition to ensuring sufficient resources and capacity to meet demand under normal operating conditions, system planning must also ensure that adequate reserves and necessary system resources exist to reliably serve demand under credible contingencies such as the loss of a generating unit, a transformer, or a transmission facility (NERC 2007).

The overall behavior of a power system with variable generation differs from one with mainly dispatchable resources, and current methods of power system planning need to be adjusted to consider the growing share of VRE. Reliability-focused equipment standards are being developed to facilitate integration of additional variable generation into the bulk power system. From a reliability perspective, a set of interconnection procedures and standards applies equally to all generation resources interconnecting to the power grid. However, the ability of the generator owner and operator to provide the following functionality is essential for VRE:

- 1) Voltage regulation and reactive power capability
- 2) Low- and high-voltage ride-through
- 3) Inertial-response (effective inertia as seen from the grid)
- 4) Control of power ramp rates and/or curtailing of power output
- 5) Frequency control (governor action, automatic generation control, reserve, etc.)

The ability and extent of variable generation to provide the above functions affects the way in which VRE can be readily integrated into the power system. Interconnection procedures recognize the unique characteristics of variable-generation technologies but focus on the overall performance of the bulk power system rather than that of an individual generator.

## INTERCONNECTION STAGES

In general, bringing a utility-scale generation resource online can be divided into three major stages (ERCOT 2012; ESMAP 2019b), each with its own set of required studies (please refer to ESMAP 2019b for more details):

- 1) Stage 1 (Interconnection Studies): Network-wide and project-specific planning encompassing various interconnections studies in addition to project development

- 
- 2) Stage 2 (Design Studies): Resource modeling and registration – and, in the case of private VREs, the signing of power purchase agreement (PPA)
  - 3) Stage 3 (Control Studies): Connection to the grid, commissioning, and testing, followed by commercial operations

In Stage 1, a series of studies are conducted to evaluate the proposed resources effect on the system. Screening study completion and a notice to proceed from the interconnecting entity (IE) set into motion the Interconnection Studies process. Once the sub-synchronous resonance (SSR) study and full interconnection study (FIS) are complete, an interconnection agreement (IA) may be reached between the plant owner and the electrical utility or market operator.

In Stage 2, the electrical utility or market operator models the new generation resource in a future planning base case. At this stage, the network model is built with the new resource node and a new network operations model to reflect changes from Stage 1. Usually, the installation of telemetry points and the creation of a SCADA plan to establish real-time communication and control are required. In terms of market operations, the market operator also establishes polled settlement meter communication, which allows gathering of real-time data for settlements.

In Stage 3, the Generation Resource’s Commissioning Plan, Request to Commission Point of Interconnection (POI), Request for Initial Synchronization, and Request to Begin Commercial Operation are submitted and approved. After these steps, the actual plant is connected to the grid (transmission infrastructure may need to be built for this to occur). Usually, the acceptance of test results showing the maximum leading and lagging reactive capability is required for approval of commercial operation.

Considering that in some countries the grid code may be incomplete or under development, it is important to carry out a comprehensive FIS (in stage 1) to analyze the impacts of the new generation supply on the grid and determine any possible adjustments that may need to be made to accommodate the successful integration. At a minimum, the following four studies are usually included in the FIS for all generation resources:

- 1) Steady-state analysis
- 2) Short-circuit study
- 3) Dynamic and transient stability analysis
- 4) Facilities study

### ***Steady-State Analysis***

A steady-state analysis is created from the most recently approved power-flow base case for the interconnection year. It will identify transmission facilities that may have a limiting impact on resource output. An (N-1) contingency analysis is performed to demonstrate that the existing or planned transmission capacity in the area will meet the electrical utility’s transmission criteria following installation of the proposed resource. The focus is on single contingencies that occur in the vicinity of the VREs. If insufficient transmission capability exists to interconnect the proposed resource without congestion, the analysis will propose facility improvements that can accommodate the interconnection proposal without limitation.

In network-wide VRE integration analysis, multiple scenarios of growing wind and solar penetration levels are created, starting with a base year and projecting into the future. The purpose of the power flow study is to determine the following (Jain and Wijayatunga 2016):

- 1) New transmission requirements (if the existing transmission line is not dimensioned to accommodate wind and solar power potential in the area);
- 2) Reactive-power compensation requirements to maintain voltage levels;

- 
- 3) Operating characteristics of the planned system – such as the mix of generators, losses in the system, active and reactive power flows, transformer tap settings, and protective relay settings; and
  - 4) System performance under emergency conditions (e.g., the loss of a transmission line, transformer, or generator) and needed amount of reserve (as well as ramping-reserve requirements).

In a VRE grid integration study, the following combination of demand and VRE generation scenarios is typically analyzed: maximum, minimum, and average. Power flow analysis of VRE integration provides two types of insights: the impact on the schedule of existing generators, and the grid's performance in emergency conditions, which determines the effect of new VRE performance on the power system.

### ***Short-Circuit Study***

A short-circuit study is required to analyze short-circuit fault-current duty, i.e., the maximum available fault current in the system, and hence the maximum level that the electrical equipment should be able to withstand. The protection system has to be configured to ensure a reliable relay protection for overcurrent caused by faults. If any of the required transmission system improvements associated with the resource result in violations of the transmission system short-circuit criteria, a plan must be devised to identify new facilities to address those violations. The initial short-circuit base-case transmission configuration is used as a base case for the resource's first planned year of commercial service.

In a grid integration study for a VRE, the maximum and minimum fault current available at the point of interconnection (POI) before and after the interconnection are simulated. The fault currents in an "after interconnection" scenario are compared to the ratings of the switchgear to determine if it can safely operate (i.e. disconnect) when three-phase and single-phase ground faults occur in the grid (Jain and Wijayatunga 2016). Short-circuit analysis is an important aspect of VRE interconnection, and therefore additional discussion on this subject is in Page 50 of Short Circuit Current Contribution.

### ***Dynamic and Transient Stability Analysis***

A dynamic and transient stability analysis is needed to examine the proposed unit's response to small and large disturbances in the grid, including transients during local transmission faults and the expected normal and delayed clearing of faults. The point of the studies is to examine the damping of oscillations caused by changes in this net load and the subsequent response of the other generators on the grid – to ensure that connecting new VRE to the grid will not decrease the overall system's capability to maintain synchronous operations of all synchronous machines during disturbances.

Disturbance events cause an imbalance in supply and demand that are corrected by frequency control – i.e., rotating inertia response, turbine governor response, automatic generation control (AGC), and manual reserve deployment exercised by dispatchers. The transient stability study determines whether (a) introducing VRE into the grid will cause the frequency to dip below the limit specified in the grid code and (b) the length of time it takes for the frequency to recover is longer than that specified in grid code. The grid code requirements must be met, so any identified code violations must be addressed through modifications of VRE characteristics, power system adjustments, installation of additional equipment, and frequency control improvements.

### ***Facilities Study***

A facilities study provides details, including estimated cost, of the facility requirements for the direct interconnection of the proposed generation resource project. The study includes conceptual design descriptions, construction milestones, and detailed cost estimates for all direct interconnection-related

---

transmission and substation facilities proposed to be installed in accordance with the findings and recommendations of the other FIS studies. (Additional details on power system studies can be found in ESMAP 2019b.)

## VRE INTEGRATION CHALLENGES

When new generation is connected to the electricity grid, the power system needs to adapt to it. Small-scale generation can to a large extent be integrated into the current electricity grid with no or minimal plant-level adjustments. For traditional large-scale generation sites, however, the power system may need reinforcement to accommodate the new generation. Small-scale electricity production, such as small-scale solar PV, is usually connected to the low voltage distribution grid, whereas utility-scale solar PV and wind turbines are connected to the medium-voltage distribution grid or regional transmission grid.

In response to the recent growth of renewable energy, four phases of VRE integration have been distinguished (see IEA 2017) to describe the progressive stages of VRE penetration in the grid, including its impacts and challenges. As shown in TABLE 3.1, each phase involves a different set of power system interconnection and operational challenges.<sup>9</sup> The following discussion will focus primarily on Phases 1 and 2, which are relevant to most of the World Bank's projects.

At low levels of VRE penetration (generally below 5–10 percent of installed generation capacity), depending on the specific characteristics of the system, the variability and forecast error of the net load (total demand for electricity minus the demand served by VRE) are dominated by the more predictable variability in power demand. In such cases, power systems can usually accommodate the integration of small amounts of VRE, using the existing operating reserves, by adjusting operating procedures. As the share of VRE increases, however, the variability and uncertainty exceed the level typically covered by existing operating reserves, and additional measures are needed.

The VRE integration challenges for grid operators and planners stem from both the inherent characteristics of VRE resources (i.e. variable with limited predictability; site-specific) and the characteristics of the system into which they need to be integrated. VRE integration challenges and costs will depend on the existing flexible resources and the quality of power supply required. In systems where consumers require high reliability and power quality, power system operators may need to spend additional effort to minimize the potential imbalances or disturbances introduced by VRE, since the cost of loss of load or damage to equipment could be high as they will lead to loss of production.

In distribution systems, the most prominent challenges relate to voltage rise and overloading of system components. Voltage rise issues emerge when the electricity generated exceeds the local demand, causing the electricity to flow in the opposite direction compared to normal operation. This reversed power flow may also affect the protection system and cause overload in system components. The various approaches to addressing these problems include distribution grid reinforcement, demand side management (DSM), energy storage, reactive power compensation, and voltage regulation. The amount of wind and solar PV that can be installed in a distribution system without violating the reliability and performance of the system depends on the design of the distribution system and on the load profile.

---

<sup>9</sup> Although only four phases of VRE deployment are presented here, further intensive VRE deployment beyond Phase 4 is conceivable (Cunningham et al. 2014; IEA 2017; NERC 2009). This would involve a structural surplus of VRE generation that could potentially cause VRE to possibly become a dominant power – one that could also provide energy for new applications, such as seasonal storage and production of synthetic fuels. This scenario would raise a completely different set of issues that are beyond the scope of this document.

Systems with a large mismatch between electricity generation and demand will find it more difficult to cope with large penetration levels, while systems with better load-matching can facilitate larger shares. Similarly, systems designed for high peak demand can facilitate more PV and wind power than systems designed for a low peak demand since the system is designed to cope with higher power levels. Other concerns relate to the size of the distribution grid, where long distribution feeder lines between the customer and the substation will likely experience increased greater voltage fluctuations and voltage rises during the day than shorter lines.

**TABLE 3.1: Phases of VRE Integration**

	Attributes (incremental with progress through the phases)			
	Phase 1	Phase 2	Phase 3	Phase 4
<b>Characterization from a system perspective</b>	VRE capacity is not relevant at the all-system level	VRE capacity becomes noticeable to the system operator	Flexibility becomes relevant, with greater swings in the supply/demand balance	Stability becomes relevant; VRE capacity covers nearly 100% of demand at certain times
<b>Impacts on the existing generator fleet</b>	No noticeable difference between load and net load	No significant rise in uncertainty and variability of net load, but there are small changes to operating patterns of existing generators to accommodate VRE	Greater variability of net load; major differences in operating patterns; reduction of power plants running continuously	No power plants are running around the clock; all plants adjust output to accommodate VRE
<b>Impacts on the grid</b>	Local grid condition near points of interconnection, if any	Very likely to affect local grid conditions; transmission congestion is possible, driven by shifting power flows across the grid	Significant changes in power flow patterns across the grid, driven by weather condition at different locations; increased two-way flows between high and low voltage parts of the grid	Requirement for grid-wide reinforcement to enable grid to recover from disturbances and maintain stability
<b>Main factor for challenges</b>	Local conditions in the grid	Match between demand and VRE output	Availability of flexible resources	System's capacity to withstand disturbances

In a transmission system, the challenges of utility-scale integration of solar and wind power are associated with optimizing utilization of the power system and the new VREs connected to the grid, as follows:

- 1) The optimal locations of power plants may change, since the optimal sites for wind and solar power plants are often not the sites where power plants have traditionally been placed.
- 2) Increasing the transmission capacity facilitates the “smoothing” of variations in the production patterns from wind and solar power. In a system with a large transmission capacity, electricity can be collected from individual VRE plants sited over a large geographical area, resulting in smaller variations in the aggregated production. Experience from Europe (e.g. Germany and the Netherlands), shows that even very high wind-power penetration levels of up to 20 percent may not require additional primary control capacity as long as the installed wind energy is geographically distributed over a wide area and the “smoothing effect” results in low short-term

---

variations in wind power production. However, in order to benefit from the variation dampening achieved by spreading wind energy geographically, the transmission network had to be enhanced for transporting wind power from one region to another.

- 3) An expansion of transmission capacity may be needed to better utilize existing system resources which are capable of managing supply and demand imbalances in the system.
- 4) Flexible alternating-current transmission system (FACTS) devices are introduced.
- 5) Congestion management is introduced to address transmission capacity limitations in the grid. Transmission constraints potentially may hinder the most desirable new energy supply from satisfying the demand and affect energy pricing. Large expansion of solar and wind electricity may affect the congestion patterns in the transmission.

The integration of a significant share of variable renewables into power grids may require a transformation of the existing networks. The following changes address the needs for system flexibility and security of energy supply in a grid with a growing number of VRE plants (Phase 2 and transitioning to Phase 3):



- 1) Improve grid stability for distributed generation by allowing (a) the flow of energy from generators to end-users to be bi-directional and (b) end-users to contribute to the electricity supply.
- 2) Improve grid management and efficient energy demand to reduce peak loads; increase grid flexibility; and provide better reactive-energy support, responsiveness, and security of supply of intermittent resources.
- 3) Improve the interconnection of grids to increase grid balancing capabilities, reliability and stability.
- 4) Introduce technologies and procedures to ensure proper grid operation stability and control.
- 5) Increase energy storage capacity to store electricity from variable renewable sources when power supply exceeds demand.

The VRE technologies are intrinsically different from the synchronous generation that constitutes the majority share of generation resources in the grid during Phases 1, 2, and 3 (see TABLE 3.1: Phases of VRE Integration). Therefore, in addition to the grid improvements for VRE adoption, additional VRE capabilities need to be provided in order to successfully participate in reliable grid operations.

One of the key operational challenges of VRE integration is the possibility of over-generation during light load conditions, when conventional generators that must be kept online are dispatched to their minimum operating level. In this situation, the power system operator must have the ability to limit or reduce the output of variable generation in order to maintain system reliability during over-generation periods. For example, to mitigate the potential for over-generation conditions, balancing-areas may (a) consider trading for export or frequency responsive reserves during light load conditions or (b) explore the use of energy storage facilities.

FIGURE 3.1 illustrates some of the essential issues of VRE integration, including the capabilities required of VREs to allow for their integration into the grid. Further discussion of these and other capabilities, integration requirements, and technical details is presented later in this section.

**FIGURE 3.1: VRE's Essential Abilities for Grid Integration**

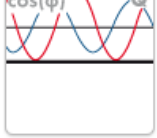
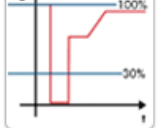
	<ul style="list-style-type: none"> <li>➤ Ability to control PV generation to a specified % of nominal power rating (Remote Dispatch)</li> </ul>
	<ul style="list-style-type: none"> <li>➤ Ability to automatically reduce active power with frequency deviations</li> </ul>
	<ul style="list-style-type: none"> <li>➤ Ability to supply/absorb reactive power during PV operation</li> <li>➤ Ability to Control Power Factor (PF Control Mode)</li> </ul>
	<ul style="list-style-type: none"> <li>➤ Fault Ride-Through (LVRT)</li> <li>➤ Ability to supply reactive current during fault ride-through period</li> </ul>

Sources: © SMA Solar Technology AG, n.d. Used with the permission of SMA Solar Technology AG. Further permission required for reuse. Adopted from WB information and other sources

Utilities usually have various technical concerns about connecting new generation to their transmission and distribution facilities and integrating it into the bulk power system. For VRE plants, most of the concerns fall into the following categories:

- 1) *Standards and Procedures.* VRE integration in the grid requires maturity of standards and procedures to ensure reliable and optimal grid operations.
- 2) *Remote Dispatch.* The dispatch capabilities are limited and require improvement.
- 3) *System area control error (ACE).* PV plants' ramp rates in the morning and evening, along with their response to clouds, are of major concern as they impact system ACE and area voltages.
- 4) *Power Quality.* VRE plants must be aware of electromagnetic transients, flicker, and harmonics impacts in the system, if only to know that their plant is not causing a system problem.
- 5) *Reactive power support and regulation.* Voltage regulation and power factor control are limited and require improvement.
- 6) *High-voltage ride-through (HVRT), low-voltage ride-through (LVRT), and islanding.* PV plants, along with all other generation, must be able to handle correctly any issues arising from new VRE interconnections and/or new grid codes.
- 7) *System-normal and contingency operation (slow regulation).* This involves the VRE plant's impact on system-normal and contingency flows and voltage.
- 8) *Transient and Voltage Stability (Dynamic Events).* The dynamic change in the VRE plant's output could, in combination with other system events, cause unforeseen, fast-acting issues.
- 9) *Fault currents.* This refers to the impact of additional VRE plants on short-circuit current ratings.
- 10) *Stability Models.* The stability models require further development for conducting studies.

## TECHNICAL REQUIREMENTS FOR VRE INTERCONNECTION

The technical requirements for VRE grid integration are determined by the design and capabilities of the electrical equipment of the connected power plant. In that regard, it is important to understand the major differences between wind and solar PV, which are summarized in TABLE 3.2.

**TABLE 3.2: Major Differences between Wind and Solar PV**

Feature	Wind power	Solar PV
<b>Variability at plant level</b>	Often random on sub-seasonal timescales; local conditions may yield a pattern.	Planetary motion (days, seasons) with statistical overlay (clouds, fog, snow, etc.).
<b>Variability when aggregated</b>	Usually with a strong geographical smoothing benefit.	Of limited benefit once “bell shape” is reached.
<b>Uncertainty when aggregated</b>	Shape and timing of generation unknown.	Unknown scaling factor of a known shape.
<b>Ramps</b>	Depends on resource; typically, few extreme events.	Frequent, largely deterministic and repetitive, and steep.
<b>Modularity</b>	Community scale and above.	Household and above.
<b>Technology</b>	Non-synchronous and mechanical.	Non-synchronous and electronic.
<b>Capacity factor</b>	20% to 50% typically.	10% to 25% typically.

Source: IEA (2016).

The following subsections describe the minimal technical requirements for integrating VRE into the bulk power system. In reality, a utility needs to consider all aspects of VRE integration as their actual implementation will in large part depend on the country’s electricity market and the utilities’ unique grid profile, including the current and the projected penetration level of VREs. Additional advanced requirements, most of which are applicable to the high penetration level of VRE into the grid, are presented in Appendix B. As shown earlier in TABLE 3.1, the technical requirements for integration of VRE plants depend on the extent of VRE deployment in the grid and the instantaneous share of VRE generation. The following are the main requirements related to VRE integration into modern power grids:

- 1) **Regulation, automatic response to grid events, and controls**
  - a) *Voltage control/reactive power control*: This relates to the ability of VRE plants to respond to voltage fluctuations at their point of interconnection (POI). Reactive power from generators assists the flow of power and variations in that reactive power will affect local voltage. All equipment connected to the system is expected to be able to operate within a range of the nominal values, typically  $\pm 10$  to  $\pm 15$  percent of the nominal value for voltage, depending on the country’s grid code.
  - b) *Frequency control/active power control*: This is the ability to provide active (or real) power regulation, particularly downwards, in response to over-frequency (measured in watts). Variations in active power output will have an impact on system frequency. The control of active power may be via AGC. All equipment connected to the system is expected to be able to operate within a range of the nominal values, typically  $-5$  to  $+3$  percent of the nominal value for frequency.

- 
- c) *Spinning reserves*: These are extra reserves of power that can be made immediately available by power plants that are already connected and operating to reduce the area control error (ACE), which is proportional to the frequency deviation, thereby correcting imbalances that cannot be corrected with AGC. In systems with non-negligible VRE penetration, spinning reserves should be quantified dynamically and proportionally to the expected VRE output.
  - d) *Fault ride-through*: VRE plants may or may not have the capability to remain connected to the network for a certain length of time during voltage disturbances. VRE plants should provide reactive power in the event of low voltage, contributing to the management of faults.
  - e) *Active and reactive power control*: This specifies the capability of mostly wind farms to limit active and reactive power production in response to signal from system operator. This is an advanced feature applicable to grids with significant variable energy penetration.
  - f) *Synthetic inertia*: This is relevant for very high shares of VRE. VRE plants do not provide inertia to the system, so at higher shares the rate of change of frequency (RoCoF) will increase. Synthetic inertia can be engineered, but this requires very advanced control methods and additional hardware components.
  - g) *Monitoring and supervisory controls*
    - i) *Metering and SCADA*: This specifies the location of installation and properties of the revenue meter, general monitoring parameters and controls for SCADA, protocols for data exchange between VRE plant and system operators.
    - ii) *Communication systems*: These are to allow the system operator to monitor the output of VRE plants in real time, as well as direct control of VRE plants via AGC.
- 2) **Power quality**: The main aspects of power quality include harmonics and flicker, which occur in terms of waveform distortions and short-term fluctuations. The limits on power quality parameters needs to be specified and respected.
  - 3) **Protection systems**: These are to isolate faults and mitigate the impact of faults on the electrical network. Standards for protection systems are required in all phases of VRE deployment. VRE plants are responsible for protecting their equipment from faults in the grid. The situations in and duration for which VRE plants should stay connected should be specified for the plants.
  - 4) **Forecasting and analysis**
    - a) *VRE resource forecasting*: This relates to tools for forecasting the output of VRE power plants over different timeframes (e.g., frequency, duration, and resolution) to help system operators and planners schedule dispatchable power plants and spinning reserves cost-effectively. Forecasting tools become more important as more VRE plants are connected to the system.
    - b) *Simulation models*: These are models that replicate the physical behavior of the electric grid, which are used to simulate possible scenarios to facilitate decision-making in power system planning and operation. Accurate and updated grid and generator models are required to ensure the accuracy of the simulation. Generation owners should provide simulation models of the power plants connected to the system.
  - 5) **Documentation of VRE facility inspection and certification**: This should specify the procedures for inspection and certification of the POI.

The technical requirements for integrating VRE into the grid are summarized in TABLE 3.3, which also compares VRE with methods used by traditional synchronous machines. The continued rapid development of VRE technologies, especially in Phase 4 (see TABLE 3.1: Phases of VRE Integration earlier in this section), will likely result in elaborations on the above list of requirements and the content of the

---

provided summary below), will likely result in elaborations on the above list of requirements and the content of the provided summary below.

**TABLE 3.3: Grid Integration Requirements**

Grid requirement	Design function	Objective	Comparison of Traditional Synchronous Units with VRE Units	
			Traditional Synchronous Unit Performance	VRE Unit Options
<b>Static Voltage Control</b>	Adjusts reactive power to maintain voltage profile or in response to central commands	As loading on transmission elements increases, their reactive losses increase. If not compensated, voltage will fall until the grid becomes unstable.	Provided through exciter /automatic voltage regulator control	Solar PV: Provided through DC-AC inverter control.  Wind: Provided through built-in controls for Type 3 and 4 turbines.  Additional reactive devices, such as capacitor/reactor banks, can be used.
<b>Dynamic Voltage Control</b>	Rapid, automatic reactive output	During and after contingency events such as fault conditions, voltage is dragged low by the fault conditions in microseconds. If immediate compensation is not provided, the grid can become unstable and collapse.	Provided through exciter controls	Solar PV: Provided through DC-AC inverter control.  Wind: Provided through built-in controls for Type 3 and 4 turbines.  Additional dynamic reactive devices, such as SVCs and STATCOMs, can be used.
<b>Inertia Response</b>	Stored energy in the rotating mass	The Inertial Frequency Response provides counter-response within seconds to arrest the frequency deviation.	Rotating mass provides inertia support	Solar PV: Synthetic inertia response.  Wind: Inertial response is inherent in Type 1 and 2 units and can be achieved through supplemental controls in the converter to emulate inertial behavior for Type 3 and 4 units.

Grid requirement	Design function	Objective	Comparison of Traditional Synchronous Units with VRE Units	
			Traditional Synchronous Unit Performance	VRE Unit Options
<b>Primary Frequency Control</b>	Automatically adjusts active power in the first seconds in response to a frequency deviation	Primary frequency control is what arrests frequency decline after a loss of generation event. Without it, the grid is unstable.	Provided through turbine governor control.	Solar PV: Provided through DC-AC inverter control to provide governor-like functions.  Wind: can be supplied by all turbines that are equipped with some form of pitch regulation.
<b>Secondary Frequency Control</b>	Under central control, restores frequency nominal and restores the generation /load balance at a secure design frequency	Without secondary frequency control (normally called AGC), frequency drifts from the grid design point, making it vulnerable to instability.	Automatic Generation Control (AGC).	Solar PV: Provided through DC-AC inverter control to provide AGC-like functions.
<b>Ramp Rate Control</b>	The rate of change in MW per minute of a Resource	To prevent a frequency deviation due to a larger generation change.	Provided through power regulation.	Solar PV: through DC-AC inverter control  Wind: provided for turbines with active-stall or pitch control, and/or discrete tripping of units.
<b>Frequency ride-through</b>	Avoids destabilizing the grid after loss of generation or load events	If many units trip during a low of high-frequency event the grid may become unstable and collapse.	Per operating guides.	Per operating guides.
<b>Voltage ride-through</b>	Avoids destabilizing the grid after fault events	If many units trip during a low of high-frequency event the grid may become unstable and collapse.	Per operating guides.	Per operating guides.  Can be achieved with modern wind turbine generators through modifications of the turbine generator controls.

Grid requirement	Design function	Objective	Comparison of Traditional Synchronous Units with VRE Units	
			Traditional Synchronous Unit Performance	VRE Unit Options
<b>Small Signal Stability damping</b>	Prevents groups of generators from oscillating against other groups	If groups of units oscillate against other groups of units without dampening, the lines between them may twist out of synchronization and island the group.	Provided through tuned stabilizers.	Solar PV: through DC-AC inverter control to provide stabilizer like functions.
<b>Sub-synchronous resonance/interaction (SSR/SSI)</b>	Prevents resonance against series capacitors, which can cause tripping of (or damage) generation resources.	Oscillation of turbine shafts, or unit controls at sub synchronous frequencies can damage generation resources and equipment.	Provided through tuning of unit design to avoid sub-synchronous frequencies or use of protective equipment.	VRE may have SSI with series capacitors at the plant or neighboring wind/solar plants.
<b>Energy schedule and forecast</b>	Provide the energy output potential for adequate system unit commitments.	For intermittent resources, forecast accuracy can affect the systems schedule and result in congestion and increasing need for ancillary service.	Able to provide firm energy schedule in combination with load control, which allows adjustment of generation output under virtually all conditions with controlled fuel feed.	Forecast of wind and solar activity provide reference to wind and solar power energy.
<b>Dynamic monitoring</b>	Provides high-resolution recorded system data (in MW, Mvar, KV, A).	Dynamic performance monitoring allows early detection of system instability and provides a reference for system event investigation after events.	Not provided for most installations.	Install PMU or DFR for each resource, but currently not provided for most installations.

Grid requirement	Design function	Objective	Comparison of Traditional Synchronous Units with VRE Units	
			Traditional Synchronous Unit Performance	VRE Unit Options
<b>Load following or tertiary frequency control</b>	Allows operator to increase and decrease electrical power and energy output on command.	Allows aggregate power output to match demand to maintain adequate system frequency.	Controlled fuel feed, in combination with load control, allows adjustment of generation output under virtually all conditions.	Due to the intermittent nature may not be able to increase output without having an active power reserve.
<b>Short-circuit current contribution</b>	Provide fault current during fault condition.	Relay setting based on fault current can mis-operate or be difficult to coordinate with other relays with low or zero short-circuit current contribution.	Conventional units generally provide 10–12 times of rated current during fault condition.	It is known that solar provides zero or minimum short-circuit current. Improve inverter size for solar and/or control design to provide short-circuit current.  Wind: Type 3 and 4 turbine fault performance is governed by control design, e.g. about 1.5–3 times of rated current during fault condition for a Type 4 turbine.
<b>Performance when connected to a weak interconnection point</b>	Normal response at weak system (for example, low or very low short-circuit ratio).	Minimum short-circuit ratio is required for the design units to have normal response.	Contributes to improvement of the system strength (increase in system inertia).	Additional testing and tuning may be needed when connected to a weak system.

---

## GRID CODE COMPLIANCE

### *General Requirements*

Many new variable generation plants interconnecting to the bulk power system are located in areas remote from demand centers and existing transmission infrastructure due to greater resource availability. As mentioned earlier, the International Renewable Energy Agency (IRENA) (New Energy Update 2017) and the Global Wind Energy Council (GWEC) (GWEC 2017) have each projected that annual worldwide installations will continue to grow at about 90GW/year for solar and more than 60 GW/year over the next five years.

Additional transmission infrastructure is therefore vital if large amounts of new VRE resources are to be reliably accommodated. The new infrastructure is needed to:

- 1) Interconnect variable-energy resources planned in remote regions or offshore,
- 2) Smooth the variable generation output across a broad geographical region and resource portfolio, and
- 3) Deliver ramping capability and ancillary services from inside and outside each balancing area to equalize supply and demand.

Grid operators and planners must determine whether network upgrades, reinforcements and/or new equipment will be required when connecting a VRE plant to the transmission or distribution grids. They must ensure that connecting a new VRE plant to the existing power system will not (a) compromise or unduly reduce the quality, security and reliability of service; (b) reduce the transmission or load-serving capacity; or (c) submit any grid equipment to operating conditions beyond its specified requirements – in other words, to the point of possibly preventing the transmission provider or load-service entity from honoring its contractual commitments.

#### **BOX 3.1 Case Studies: Brazil and Texas**

In Brazil, some 2 GW of newly built wind plants stood idle in 2013 due to insufficient grid capacity. Although the plants were receiving payment for electricity that they would normally have generated (in line with a signed PPA), they were unable to feed into the grid. Since then, the risk of such delays has been borne by wind developers: if a wind plant is unable to feed into the grid, it will not receive the agreed payment. (By the end of 2015, only some 300 MW of wind capacity awaited a connection.) Two changes resulted: more-recent wind power projects have tended to be sited close to existing grid, and to participate in an auction a wind power project must now include the transmission element.

In Texas, zoning has been used since 2005 to plan the location of wind power plants to optimize grid development. In that year the Public Utilities Commission of Texas (PUCT) designated Competitive Renewable Energy Zones (CREZ) to break an impasse between deployment of new transmission and the building of wind farms, each of which activity was hindered by the absence of the other. Five zones covering much of West Texas were selected, and the PUCT chose from among several options a plan to build new 345 kV lines to accommodate an additional 11.5 GW of wind power generation capacity. The success of this approach was the fact that transmission expansion could be started ahead of plant construction, ensuring that it would be ready in a timely fashion.

In general, as a first rough approach, the short-circuit power, or short-circuit ratio (SCR), of the existing power system could be one major parameter to be considered at the point of common coupling (PCC) or point of interconnection (POI) – i.e., the place where the VRE resource will be connected to an existing power system at either the transmission or distribution level. The SCR, a commonly used metric for

quantifying the power system’s strength at a connection point, is calculated by dividing the short-circuit power (in megavolt-amperes, or MVA) at a connection point by the installed level of power-electronic-connected generation (also in MVA). The SCR at the connection point strongly influences a plant’s ability to operate satisfactorily both in steady state and following a system disturbance. Calculating the SCR will give the planners an idea of (a) the maximum amount of VRE generation that can be integrated without major impacts to the power system. For instance, for wind farms, the features of frequency ride-through (FRT), voltage ride-through (VRT), acceptable harmonic pollution, as well as the related harmonic filtering solutions more or less in the same way the SCR is used to assess the feasibility and power quality of HVDC power systems when integrated into already existing power systems (through selection of the nominal rating and main features).

Therefore, the size of individual generators, combined with the geographical location or penetration levels of the VRE resources, will define the voltage level at the POI – as well as the requirements in terms of availability, reliability and power quality of the VRE resource, and any necessary upgrade to the power system. Thus, the aspects of reinforcements of the power system (close to the POI), if required, should also be part of the technical assessment.

The level of reliability of the connection point itself (including substation layout and busbar schemes) will depend on the voltage level and penetration level of the VRE resources to be integrated into the power system, taking into account the features and reliability requirements of the existing power grid. Thus, since the power systems differ for each country or region, the assessment of such issues will determine the requirements in a ‘tailor-made basis’.

The following two examples – one from an advanced power system in Germany, and one from a small system in Barbados – demonstrate reasonable approaches to voltage-level selection.

**BOX 3.2 Example 1: VRE Interconnection in Germany**

The type of renewable energy source often affects the size of the generation plants – and thus the type of grid connection, which is generally classified by voltage level, as shown in **Error! Reference source not found.**

**TABLE 3.4: Overview of Voltage Levels in Germany**

Name (IEC Definition)	Abbreviation	Rated Voltage	Role
Extra high voltage	EHV	380 kV, 220 kV	Transmission grid
High voltage	HV	110 kV	Distribution grid
Medium voltage	MV	30 kV, 20 kV, 15 kV, 10 kV	
Low voltage	LV	400 V	

Source: Corfee et al. (2011).

In the German grid, the voltage level at the POI for the VRE plants follows the schema shown in Table 3.5.

**TABLE 3.5: General Rules for Selecting the Voltage Level of the POI**

Rated power of the generation plant	Voltage level of grid connection
Up to 30 kW	Low-voltage grid without verification
30 to 200 kW	Low- or medium-voltage grid
0.15 to 20 MW	Medium-voltage grid
15 to 80 MW	High-voltage grid
80 to 400 MW	Extra-high-voltage grid

Source: Corfee et al. (2011).

### **BOX 3.3 Example 2: VRE Interconnection in Barbados - Small-Scale System**

The transmission system in Barbados runs at voltages of 24.9 kV and 69 kV before being transformed down to 11 kV for distribution feeders. Topologically the power system is unmeshed, and mostly radial.

There are two types of generation on the island: single- and three-phase. For *three-phase* generators, the individual generation limits for three-phase DG facilities connected to the Barbados Light and Power (BL&P) distribution system feeders are as follows:

- 1) 1 MW per connection on feeders operating at 11 kV; and
- 2) 25 MW per connection on 24.9 kV feeders. There may be only one connection on a 24-kV transmission system.

The feeder limitation determines the total acceptable three-phase generation allowed for all sections of BL&P's transmission and distribution system feeders. These limits are:

- 1) 5 MW for feeders operating at 11 kV
- 2) 25 MW for transmission feeders operating at 24.9 kV

The maximum *single-phase* generation limits for specific feeders cannot exceed 150 kW for single-phase generators connecting to feeders operating at nominal voltage levels of 11 kV. (Where several single-phase DG facilities are located on a three-phase feeder, every effort must be made to balance the associated currents.) Also, no single-phase generators shall be connected to feeders operating at nominal voltage levels of 24.9 kV.

*Source: Barbados Light and Power Company Limited (2014).*

Even though some countries have a general rule of thumb for choosing the voltage level at which to connect these distributed sources, it in fact depends on how robust the system is – for example, how meshed the transmission system is, the SCR level, the voltage level to be used for connecting the VRE, and feeder lengths of the distribution system (in this last case for connecting the VRE directly to the distribution level). These are all critical factors in limiting the maximum allowable generation size in different locations of the power systems.

Regarding specifically the connection of VRE at the distribution level, the length of feeders is generally a constraint for defining the size of the generation amount in the end of those feeders, due to the voltage drop that can potentially happen in those distribution lines. The best practice, however (technically and economically speaking), is to have one or more dedicated feeders (as necessary) connected to the low-voltage side of the substation for a given PV or wind plant that are medium sized of around 10 MW.

Depending on the context, the grid codes, generator size (MVA), generator technology, connection point and voltage level, there will be some minimum requirements that should be applied to all VRE generators. Beyond these minimum requirements, some generators, especially in power systems with high level of VRE penetration, will be subject to additional advanced requirements, some of which are covered in detail in Appendix B.

Grid code compliance is an important requirement for VRE integration that is usually defined in the technical specifications for VRE power plants (see Page 8 under “Essential Considerations for Technical

---

Specifications” for both solar and wind power). However, the basic requirements for grid interconnection need to be outlined even for utilities that, although perhaps operating in countries that lack a mature and established grid code, nonetheless must pursue high operational standards so as ensure grid code compliance in the future. The following represents a sample approach that can be used for wind turbine integration with an eye toward future grid code standards.

A wind turbine must provide a controlled and predictable power response from variations in wind and grid frequency while maintaining compliance with applicable power-quality and grid-interconnection standards, such as the following U.S. standards:

- 1) Federal Energy Regulation Commission Order 661a, Appendix G, “Interconnection Requirements for a Wind Generating Plant”
- 2) IEEE Standard 519, “Harmonic Limits”
- 3) ANSI C84.1, “American National Standard for Electric Power Systems and Equipment – Voltage Ratings”

With respect to zero-voltage ride-through, the wind turbine must be capable of remaining in service (i.e., connected to the grid) during a three-phase fault for a period of up to nine cycles (0.15 seconds) at zero voltage, as measured at the high side of the step-up transformer.

The wind turbine should be capable to operate within a frequency range of 60 Hertz  $\pm$  2 Hz.

The wind turbine should be able to provide active power control using the following, at a minimum:

- 1) Ramp rate control, permitting an active-power response of up to 10 percent of rated power per second; and
- 2) Delta control, permitting the turbine to be operated at a specified output level (delta) below the available output level.

Reactive power control has to be provided by the turbine to assist with regulating grid voltages. The project (inclusive of all turbines) must maintain a power factor within the range of 0.95 leading to 0.95 lagging, as measured at the point of interconnection.

Total harmonic distortion must be no greater than 5 percent.

A more detailed and systematic analysis of general VRE grid connection requirements is presented in the following sections.

---

### **BOX 3.4 Case Study: Wind Farm Integration**

In Brazil, where the approach is broadly similar across most utilities, the size of wind turbine generators (WTGs) is determined by site wind profiles as well as available technology; the optimum technical and economical solutions are based on site assessments examining the feasibility of wind farm implementation. Generator size ranges from 1.8 to 3.0 MW; height can reach 120 meters, measured from the ground to the axis of the generator; and the capacity factor is usually higher than 50 percent at the best sites. The total size of the wind farms and definition of the POI<sup>10</sup> (and consequently the voltage level used) of course depends on the assessment regarding the impact the turbine's generation will have on the security, reliability and power quality of the existing transmission or distribution systems – and on the technical and economic assessment mentioned earlier. Most utilities follow this practice when implementing VRE generation.

### ***System Operation Requirements***

Operation ranges for voltage and frequency in general are relevant for all power systems regardless of their size and VRE penetration. The actual voltage ranges may differ between voltage levels, whereas the frequency range is usually the same within all voltage levels of a power system.

Operation ranges describe how far voltages and frequency in reality may deviate from the normal tolerance band, which can never be maintained exactly due to the physical properties of the grid and its generators and loads. All equipment is therefore able to operate within some tolerance around the nominal values. However, larger deviations can cause equipment to malfunction or can cause permanent damage or curtailment of operational life-cycle.

Hence, voltages and frequency deviations outside the given tolerances, and which VRE generators are expected to ride through, are addressed in the HVRT, LVRT and FRT requirements.

A typical voltage tolerance band for unrestricted operation of generators is  $\pm 10$  percent of the nominal value, while for the power systems this range is usually  $\pm 5$  percent (especially for transmission level and nominal voltages above 110 kV). At high voltage levels, asymmetric thresholds are often given in acknowledgement of operator practices such as the tendency to operate slightly above the nominal voltage value to reduce losses.

The frequency tolerance is usually around  $\pm 2$  percent in large interconnected systems. The required range incorporates a safety margin around the frequency range that can usually be maintained by the system's frequency control scheme in case of certain large disturbances. In smaller systems or island systems, usually larger frequency bands are required, because frequency control is harder to handle in smaller systems.

Outside the given tolerances, generators must remain operational for a minimum time interval or may disconnect immediately, depending on the magnitude of the disturbance as well due to security and reliability requirements. The specified time intervals provide a safety margin for the system operator to respond to disturbances.

---

<sup>10</sup> The POI(s) would be defined according to the impact assessment conducted for each wind farm (or any VRE plant), which verifies whether the farm is violating any system requirements and specifies an appropriate voltage level for the connection. Any violations would require some compensation and system reinforcement in order to receive interconnection approval (IA) from the utility or regulating body.

**FIGURE 3.2: Operation Range**

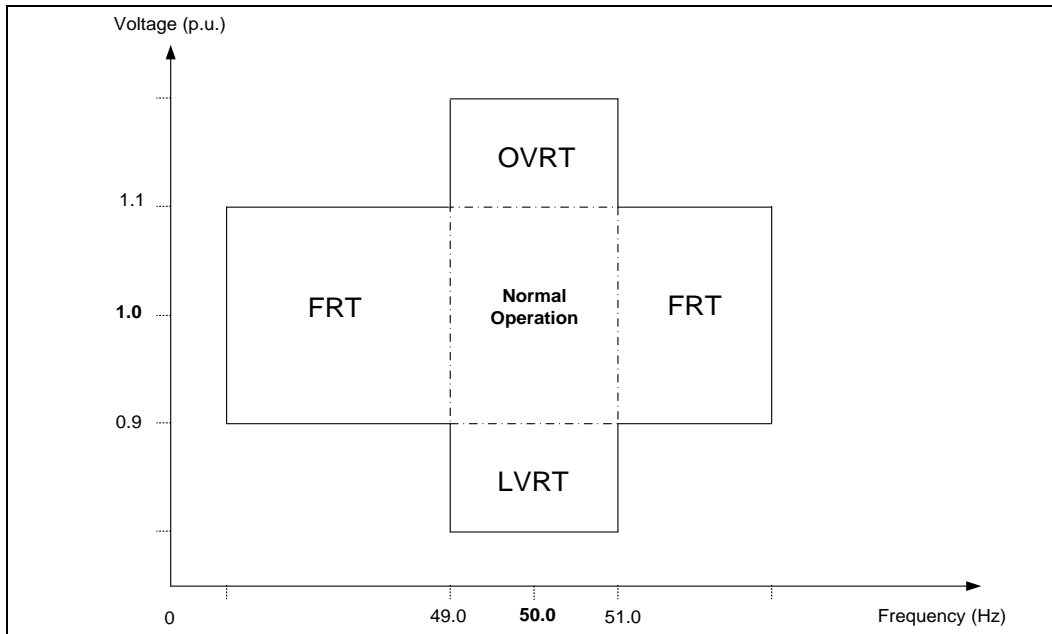

FIGURE 3.2 illustrates typical operation ranges during normal and FRT/HVRT/LVRT conditions (for a 50 Hz system).

### ***Ancillary Services***

The Federal Energy Regulatory Commission (FERC) defines ancillary services as “those services necessary to support the transmission of electric power from seller to purchaser given the obligations of control areas and transmitting utilities within those control areas to maintain reliable operations of the interconnected transmission system.” FERC identifies the following types of ancillary services:

- 1) Scheduling and dispatch
- 2) Reactive power and voltage control
- 3) Loss compensation
- 4) Load following
- 5) System protection
- 6) Energy imbalance

Ancillary services are a vital part of balancing supply and demand and maintaining bulk power system reliability. Organizations have for decades taken advantage of demand aggregation, provision of ancillary services from other jurisdictions, and interconnected system operation. Since each balancing area must compensate for the variability of its own demand and random load variations in individual demands, larger balancing areas with sufficient transmission proportionally require relatively less system balancing through “regulation” and ramping capability than smaller balancing areas. Smaller balancing areas can participate in wider-area arrangements for ancillary services to meet Control Performance Standards (e.g. CPS1 and CPS2 in North America).

Sufficient bulk power transmission, larger balancing areas, or participation in wide-area arrangements can offer reliability and economic benefits when integrating large amounts of variable generation. In addition, they can lead to increased diversity of variable generation resources and provide greater access to more dispatchable resources, increasing the power system’s ability to accommodate larger

---

amounts of variable generation without the addition of new sources of system flexibility. Balancing areas should evaluate the reliability and economic issues and opportunities resulting from consolidation or participating in wider-area arrangements such as ACE sharing or wide area energy management systems.

In many locations, balancing energy transactions are scheduled on an hourly basis. With the advent of variable generation, more-frequent and shorter scheduling intervals for energy transactions may assist in the large-scale integration of variable generation. For example, as noted above, balancing areas that schedule energy transactions on an hourly basis must have sufficient regulation resources to maintain the schedule for the hour. If the scheduling intervals are reduced – to 10 minutes, for example – economically dispatchable generators in an adjacent balancing area can provide necessary ramping capability through an interconnection.

The reactive power and voltage control service can be provided from the power electronics converters. The voltage regulation has been traditionally performed on transmission lines, because distribution networks were passive networks. Nevertheless, the recent profusion of renewable energy sources directly connected to distribution networks has extended the voltage regulation problem to these networks. The renewable energy sources can provide some ancillary services; for example, a PV generation system can provide reactive power each time the active power available from the source is lower than the rated capacity of the plant (reactive power can also be provided by the plant through inverter control even at maximum generation levels when the inverter capacity is oversized). This eventuality occurs for many hours during the day and, consequently, it can participate in voltage regulation with no additional costs. The requested amount of reactive power can be obtained from the PV system for loads that request these services and are connected at the same node. Similarly, a PV generation unit can compensate current harmonics measured on the grid. In this way, it is possible to suppress all the harmonics resulting from loads connected at the same node as the PV system – removing the need to install an expensive interface converter.

#### **BOX 3.4 Case Study: ERCOT**

The Electric Reliability Council of Texas (ERCOT), a U.S. market operator, is undergoing a redesign of ancillary services markets as part of its Future Ancillary Services (FAS) proposal. This redesign is driven by the perceived need to meet future system demands as the penetration of variable energy resources increases, while also accommodating new opportunities to meet those needs. It aims to incorporate a variety of advanced energy technologies into the marketplace, including faster-ramping thermal generation, energy storage, automated demand response (DR), distributed generation, and renewable generation.

For example, FAS has introduced a new product called Fast Frequency Response 1 (“FFR1”) that advanced batteries and fly-wheels can provide. Load resources could also provide a similar product called “FFR2,” similar to how they provide responsive reserves today. ERCOT estimates that approximately 1,400 MW of load resources are capable of meeting the requirements of FFR2. Both types of FFR would provide more-rapid frequency response than traditional resources when compensating for sudden unplanned outages at large thermal units; current proposals would require FFR resources to deliver their full response within a half second.

In the longer term, ERCOT is also exploring whether a shift from conventional fossil fuels to VRE may lead to a loss of system inertia, which is traditionally supplied by synchronous generation (which involves spinning generators – typically generators with spinning mass such as fossil-fuel or hydro resources). If validated, this concern may in future merit the introduction of some new ancillary service to incentivize synchronous inertial response (SIR). In that context, ERCOT is also evaluating the extent to

which synthetic (or emulated) inertia from inverter-based generation sources (such as wind turbines) might be able to provide the necessary capabilities in the future. While practical experience with wind generators providing synthetic inertia is limited, it appears that at least under some conditions inverter (or equivalent) technologies can provide some of the inertia services typically provided by synchronous equipment (see Appendix B).

Source: ERCOT (2016)

### **Frequency Ride-Through**

Reliability rules generally require utilities to implement automatic load-shedding schemes that respond to under-frequency events, and bulk generators are typically required to have under-frequency ride-through capability that extends beyond these load shedding frequency duration curves. Although loss of generation due to an over-frequency event would appear to help correct the generation-load mismatch, excessive loss of generation can rapidly turn an over-frequency event into an under-frequency event due to overcorrection. Thus, generators are required to have a defined high-frequency ride-through capability. The frequency ride-through (FRT) requirement specifies a frequency-duration profile as a means of measuring and comparing power system performance with plant (VRE generators) FRT capability. VRE generators should then be able to remain in service without tripping during such frequency variations (in Hz).

VRE generators should also be able to remain in service without tripping with a minimum frequency gradient (in Hz/sec).

The development and validation of frequency-duration profile as well as frequency gradient should be based on dynamic studies.

The sample frequency-duration profile shown in TABLE 3.6 power plants to the Hydro-Quebec system in Canada.

**TABLE 3.6: Example of a Frequency-Duration Profile (for 60 Hz System)**

Under-frequency (Hz)	Over-frequency (Hz)	Time-duration
$59.4 \leq F \leq 60.0$	$60.0 \leq F \leq 60.6$	continuous
$58.5 \leq F < 59.4$	$60.6 < F \leq 61.5$	11 min
$57.5 \leq F < 58.5$	$61.5 < F < 61.7$	90 sec
$57.0 \leq F < 57.5$	N/A	10 sec
$56.5 \leq F < 57.0$	N/A	2 sec
$55.5 \leq F < 56.5$	N/A	0.35 sec
$F < 55.5$	$F \geq 61.7$	instantaneous

### **Voltage Ride-Through**

*Voltage ride-through* refers to the capability of electric generators to stay connected during short periods of lower or higher electric network voltage. Much like the frequency-duration profile mentioned in the previous section, the requirements specify a *voltage*-duration profile as a means of measuring and comparing power system performance with plant (VRE generators) FRT capability. VRE generators should then be able to remain in service without tripping during such voltage variations.

---

The development and validation of a voltage-duration profile should be based on dynamic studies. As a minimal requirement, the VRE resources should not be tripped off during dynamic (i.e. electromechanical) oscillations due to disturbances in the power system. These electromechanical oscillations may result from generation or load rejection (when some generation or load shedding could occur as well, as a mitigation measure), or from the tripping out of lines or power system equipment (such as power transformers) during short-circuit occurrences in the power system. These dynamic oscillations (of frequency and/or voltage) will depend on the power system's features – such as its equivalent inertia (connected synchronous machine inertia stores rotational energy, thus helping maintain the transient stability and mitigating the frequency and voltage oscillations), short-circuit power, topology, loading (low/high), and dynamic control performance (from synchronous machines, dynamic voltage-control equipment such as SVCs, and/or power electronics) (ESMAP 2019a).

Wind and solar resources are typically located far from load centers, and in general economic and environmental concerns are pushing new generation to be remote from the load centers. This means planners must pay increasingly careful attention to the issues of voltage stability and regulation. Also, there are many regions where voltage stability has declined under the burden of a growing residential load, particularly from residential air-conditioning and distribution generation. A typical solution for these scenarios has been the addition of reactive compensation (e.g. static VAR compensation) at the transmission level near load centers.

An example of the co-evolution of operational procedures and technological capabilities is the requirement of ERCOT (a market operator in Texas) that wind generators, having signed interconnection agreements, provide voltage ride-through capabilities. As a result of ensuring the ability to continue operating during short-term periods of voltage fluctuation rather than automatically shutting down, the newer wind generators do not have to disconnect when system voltage levels rise above or fall below the target level of 60 Hz. In the absence of voltage ride-through capability, the system operator has to set aside sufficient resources to be able to react to a potentially large set of generating resources (in this case wind generators) disconnecting from the system, which might turn a small problem into a much more severe one.

#### *LVRT*

FIGURE 3.3 illustrates a typical low-voltage duration profile as follows:

- 1) Area A: The VRE generator must stay connected to the grid and maintain normal production.
- 2) Area B: The VRE generator must stay connected to the grid. It must provide maximum voltage support by adding sufficient controlled reactive current to ensure that the wind power plant helps to stabilize the voltage within the design framework offered by the current VRE generator.
  - a) Temporary blocking or runback of VRE generators may not be authorized.
- 3) Area C: Disconnecting the VRE generator is allowed.

**FIGURE 3.3: LVRT Requirement**

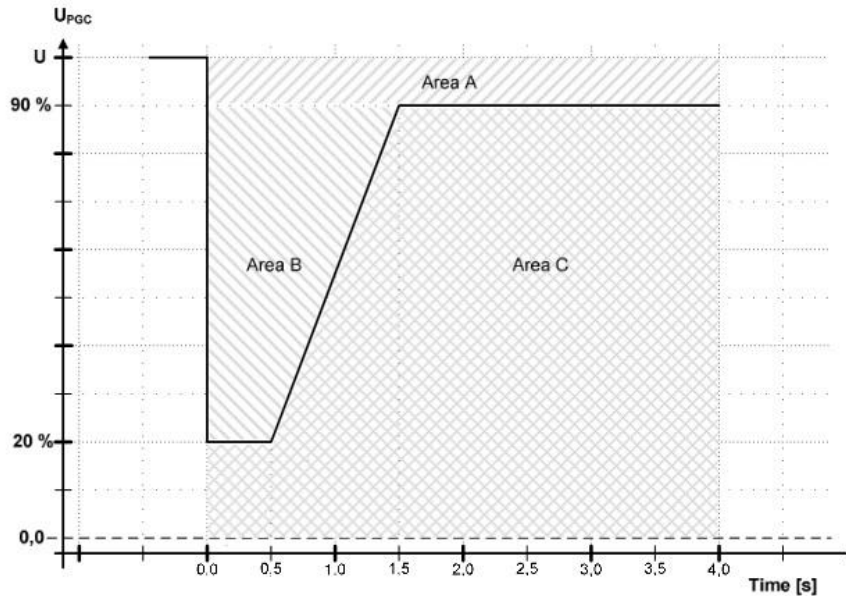

*HVRT requirement*

TABLE 3.7 indicates over voltage-duration thresholds. These values are provided as an example and are those used for post-transient disturbances, as taken from the technical requirements for the connection of Power Plants to the Hydro-Quebec system in Canada.

**TABLE 3.7: Example of Overvoltage Duration Thresholds**

Overvoltage (pu)	Time duration
$1.0 \leq V \leq 1.1$	continuous
$1.1 < V \leq 1.15$	300 sec
$1.15 < V \leq 1.20$	30 sec
$1.20 < V \leq 1.25$	2 sec
$1.0 \leq V \leq 1.1$	continuous

The development and validation of the voltage-duration profile as well as the frequency gradient should be based on dynamic studies.

***Dynamic Overvoltages***

There are many different system disturbances that can result in dynamic overvoltages (DOVs), which are high voltages on a 50/60 Hz system. DOVs are typically fundamental frequency overvoltages. They can occur within a cycle, but they may remain on the system until some other action is taken. They normally result when an event leaves capacitance on the system that provides more reactive power than the system can use in its changed configuration. DOVs do not necessarily have high peak voltages, but their duration can result in equipment damage and failure if they are not reduced. In some case, DOVs reach the protective levels of the arresters which can quickly cause the arresters to fail. Some typical causes of DOVs are:

- 
- 1) Transmission line and cable tripping
  - 2) Load rejection or interruption
  - 3) Isolating shunt capacitors on a weak system
  - 4) Open-ended lines and cables

For renewable-energy collector systems<sup>11</sup>, the main event of concern for DOVs is the disconnection of a collector feeder with generation still connected and providing power to the feeder. Fortunately, for those systems that do not have a synchronous or asynchronous generator connected directly to the system, but only have an inverter, the inverters will block power if the voltage goes too high, limiting the voltage rise. Wind generation has several types of systems where the asynchronous (induction) generator is connected to the collector system. In this case, there are some special grounding requirements needed to minimize overvoltages during tripping of a feeder. One common method of mitigating the high voltage is to have a fast grounding switch to close and ground each phase immediately after opening the feeder.

### ***Short-Circuit Current Contribution***

By definition, the short-circuit current is limited only by the circuit inductance. The current in an inductor cannot change instantaneously from the initial value (zero) to the steady state value. To achieve a current balance at the instant of short-circuit initiation, the short-circuit current can be considered to consist of an AC component (the symmetrical component) and a DC component, which accounts for the difference between the steady-state short-circuit current at the instant of fault initiation and the initial zero value. The DC component of the short-circuit declines exponentially from the initial value, with a time constant that is determined by the values of the circuit inductance and resistance.

The DC component concept underlies the requirements contained in the 1999 revisions to the major circuit breaker standards, including ANSI/IEEE C37.04, C37.06, C37.09 and C37.010. Connecting wind turbine generators to an existing power system may increase the asymmetric (total) short-circuit currents in the system; this is not an issue for solar PV, however, because PV panels do not affect these currents in the power system since it is a convertor based VRE generation.

In cases where a wind power plant is located far away from load centers, the grid near the plant will be weak, which means that the minimum short-circuit MVA is low – that is, a fault on the grid that is far away from the interconnection point does not appreciably increase the short-circuit current at the wind power plant interconnection point. Since the short-circuit current is not appreciably higher during the fault, the switchgear keeps the plant connected to the grid, which may represent a safety hazard.

The results of a short-circuit study are used to verify whether the existing protection system is adequate when a VRE is connected to the grid, and whether there is a need to strengthen the grid at the VRE point of interconnection.

---

<sup>11</sup> Collector systems (a terminology generally used for wind farms) is the point where the individual VRE generators feed into a common feeding point into the power system. The collector system or a set of collector systems, depending on the system configurations, are interconnected to the bulk grid through the POI.

---

## ***Power Quality***

The following standards applicable to power quality should be considered in the context of VRE interconnection as they explain most of functional requirements, limitations, and impacts associated with the power quality aspects of interconnection:

- 1) IEEE SCC-22: Power Quality Standards Coordinating Committee
- 2) IEEE 1159: Monitoring Electric Power Quality
- 3) IEEE P1564: Voltage Sag Indices
- 4) IEEE 1346: Power System Compatibility with Process Equipment
- 5) IEEE P1100: Power and Grounding Electronic Equipment (Emerald Book)
- 6) IEEE 1433: Power Quality Definitions
- 7) IEEE P1453: Voltage flicker
- 8) IEEE 519: Harmonic Control in Electrical Power Systems
- 9) IEEE P519A: Guide for Applying Harmonic Limits on Power Systems
- 10) IEEE P446: Emergency and standby power
- 11) IEEE P1409: Distribution Custom Power
- 12) IEEE P1547: Distributed Resources and Electric Power Systems Interconnection

It should be noted that the main emphasis of the IEEE 1547 standard is the installation of distributed resources on primary and secondary distribution systems. The distributed-resource technologies with aggregate capacity of 10 MVA or less at the point of common coupling are usually not considered to be utility-scale plants, and therefore they are out of the scope of this document.

### ***Asymmetry***

Unbalance conditions in the point of interconnection need to be analyzed and mitigated if they are above the specified limit. They may happen due to either VRE generation unbalances or load asymmetries.

### ***Flicker and Rapid Voltage Changes***

The power quality in the bulk grid maybe affected by utility-scale inverters in a solar plant when a fast-moving cloud causes a momentary drop in the power being generated by that solar plant facility. The VRE connected to the grid usually has power factor control to compensate for quick changes in weather conditions that can affect the grid's quality of power. If one of those multiple grids responds slower than another in trying to keep a voltage level steady within a small percentage variance, the slower grid could experience a drop as much as 5 percent, an unacceptable "voltage flicker". The magnitude of the "flicker" depends upon the "stiffness" of the line – which involves the voltage level, the distance from the substation, the size of the substation transformer, and the electrical design of a solar plant or wind turbine facility. Flicker can not only result in light density fluctuations, but can also affect electrical equipment – for example, by reducing the quality of welded connections.

Flicker compensation is different from reactive power compensation. During a VRE flicker event, the power factor is not targeted as much as keeping the voltage constant during rapid changes in load. Voltage drop during a load change is split into two components: a drop in actual voltage and a drop in reactive voltage. The compensation power can be fed through dynamic compensation systems and/or active filters, depending on how dynamic the load fluctuations are. Another method is to change the operating behavior of the load or increase the short-circuit capacity, which will also help decrease flicker. The short-term behavior of the load needs to be measured in each case in order to configure suitable flicker compensation.

---

Flicker caused by capacitor bank switching or load asymmetries (like arc furnaces) is usually mitigated by switched capacitor banks or SVC applications for arc furnaces.

### *Harmonic and Inter-Harmonic Distortions*

PV generation systems and many wind technologies use converters to provide AC power to the collector system. These converters create harmonics of varying levels that result in harmonic currents flowing through the step-up transformers from the converters to the collector system. During the early development of these wind farms, as converters started to replace simple induction generators, transformer specifications for these converter technologies did not always consider the harmonic loading of the transformers. Some of the transformer failures of these early converter technologies were probably due at least in part to the harmonics. Today, most wind turbine suppliers provide requirements for the step-up transformers that include the harmonic-loading and power-factor capabilities required of the transformers.

Harmonic overvoltages (HOV) are typically overvoltages resulting from a harmonic resonance in the system. The collector system for wind farms typically comprises underground 34.5 kV cables. As wind farms have become larger and collector systems have had substantial additional (e.g. 100–200 MW) generation connected, more-extensive cable systems have been required. The capacitance of the new, larger systems can lower system resonance into a range where it may amplify the harmonics.

In order to address the overvoltages and power quality issues caused by harmonics, a thorough harmonic analysis must be performed – including an analysis of harmonic load flow, a frequency scan, and a detailed harmonic analysis using harmonic sources specified either by measured data or by data from the turbine manufacturer. Existing shunt capacitor banks can be detuned to the system resonance frequency to avoid any potential HOVs. If the system produces harmonics, the equipment in the system must be rated to withstand the effects of harmonics – in addition to meeting requirements for power quality at point of interconnection.

An important consideration is specifying the harmonic loading on the transformers so they can withstand these harmonics and the overheating caused by the harmonics. Most utilities follow IEEE 519 guidelines for voltage and current distortions limits at the point of interconnection. Adding tuned harmonic filters can reduce the harmonic impedance at the resonance frequency, thereby reducing the potential to cause HOV. The specification for harmonic filters must include the ability to reduce the voltage distortions to acceptable values, as well as to support the current requirements and stresses imposed on the components of these filters throughout their lifetimes. The filtering solution can be passive, active or hybrid.

The issue of power quality (flicker, harmonic distortion and inter-harmonic distortion) is important for defining the requirements for VRE integration into existing power systems. From the harmonics point of view, it is necessary to check the harmonic injection level from the new VRE plant to the system in order to verify if it is distorting the voltage in the external system beyond the acceptable levels defined by grid codes or by internal rules of utilities.

## **DEVELOPMENT OF VRE-RELATED GRID CODE**

The main objective of any grid code is to ensure proper coordination of all components in a power system while establishing the rules and specifications that all parties in the system must follow. Grid codes cover many aspects of system operation and planning, including the following:

- 1) Rules of behavior that individual system components (such as generators and loads) must follow during both normal and exceptional operating conditions.

- 
- 2) Procedures used by system operators, including power-plant scheduling and dispatching and the use of reserves when responding to imbalances.
  - 3) Rules for planning grid expansion and new generation capacity.
  - 4) Rules of electricity trade, including the incorporation of technical restrictions in energy pricing.

In terms of VRE integration, the main focus of the grid code is to define electrical performance requirements for generating assets (mainly those related to voltage and frequency), operational and dispatch rules, and the technical requirements for interconnection to the grid. Due to the particular characteristics of VRE, additional standards (or amendments to existing ones) are critical to define aspects that may be especially important for VRE and the VRE providers' responsibility to provide any other key data needed by the grid operators and dispatch centers. If properly implemented, appropriate grid codes can considerably reduce the potential adverse impacts of grid-integrated VRE while paving the way for VRE to become an intrinsic part of the grid integration solution (IRENA 2015).

A comprehensive, up-to-date grid code that addresses the unique aspects of VRE allows the network operator to provide clear legal rules and technical requirements for wind and solar plant operators when integrating with the country's electricity networks. An IRENA report (Ackermann et al. 2016) presents a detailed analysis to demonstrate the grid code's essential role in successfully integrating large-scale VRE into a network. By considering all major components of the integration – technology, operation, and regulation – a robust grid code will ensure secure electricity service for consumers while adapting to new technologies and operational practices as they mature.

---

## 4 | CONCLUSION: ESSENTIAL REQUIREMENTS FOR VRE GRID INTEGRATION

The steady growth of VRE in modern power systems has driven not only new VRE standards, functionality and capabilities, but also grid connection requirements. An adequate grid interconnection, while needed for any new generation resource, is particularly important for generation resources whose electricity production is intermittent in nature.

Usually, a grid code establishes rules for VRE connection to the power system. These requirements become more elaborate as the penetration of VREs into the grid increases. The higher level of penetration results in the need for advanced VRE capabilities, stronger regulation support and better storage facilities required from the grid. However, even in countries that have not yet developed a grid code, new VRE generation facilities still need to comply with a basic set of technical standards and the rules of interconnection to ensure reliable operations both of a VRE as an individual plant, and a grid as an interconnection of multiple energy resources with new VRE.

Section 3, as part of its guidance on VRE integration processes and essential grid needs, described the minimum VRE capabilities and requirements required for successful VRE integration into the grid. Ideally, grid code compliance is verified throughout the operating life of a VRE project, from the planning, installation, and commissioning stages through to the end of the project. The actual set of applicable requirements, along with their priorities, is dictated by individual project factors, the particulars of the country grid code, and the extent to which the grid code is enforced. In the absence of a strong grid code, it is still important to establish technical requirements, general rules, and key guidance for applying the VRE integration requirements.

Therefore, in the course of VRE project planning and implementation, a checklist of essential requirements can help guide preparations for VRE connection to the grid. Table 4.1 recaps the most important grid requirements discussed in this technical guide; the last column specifies the document sections where each grid requirement is discussed. The assumption is that the VRE power plant in question is a utility-scale plant. The table captures grid requirements only for two different levels of VRE grid share: less than 10 percent, and between 10 and 30 percent. Because a VRE penetration over 30 percent is not typical for most World Bank projects, it is considered beyond the scope of this document.

**TABLE 4.1: Checklist of Essential Requirements for VRE Grid Integration**

VRE Share in the Grid		Document reference
Less than 10%	Between 10% and 30%	
<u>Power quality.</u> Includes harmonics and flicker, which occur in the form of waveform distortions and short-term fluctuations.		0
<u>Protection system.</u> The capability of isolating faults in the power system and mitigating the impact of faults on the electrical network. Standards for protection systems are required for any level of VRE penetration in the grid.		0; 0
<u>Frequency range of operation.</u> All equipment connected to the system is expected to be able to operate within a range of the nominal values, typically -5% to +3% for frequency.		Page 62
<u>Voltage level of operation.</u> All equipment connected to the system is expected to be able to operate within a range of the nominal values, typically ±10% to ±15% for voltage.		0
<u>Fault ride-through capability.</u> VRE plants should provide reactive power in the event of low voltage, contributing to the management of faults.		0
<u>Frequency ride-through.</u> The capability of VRE to remain in service without tripping during frequency variations. Without FRT requirements, large amount of generation capacity could be tripped simultaneously as a result of a bulk grid event that stresses the grid.		Page 46
<u>Voltage ride-through.</u> The capability of electric generators to stay connected during short periods of lower/higher electric network voltage. Without VRT requirements, large amount of generation capacity could be tripped simultaneously as a result of a bulk grid event that stresses the grid.		0
<u>Communication and SCADA.</u> The capability of the system operator to monitor the output of VRE plants in real time while maintaining direct control of VRE plants via AGC.		0
<u>Reduction of power output during high-frequency events.</u> The capability to contribute to regulation through active power reduction.	<u>Frequency and active power control.</u> The capability to provide active power regulation, particularly downwards in response to over-frequency (active power, or real power, measured in watts). Variations in active power output will have an impact on system frequency. The control of active power may be via AGC.	0; Page 60
<u>Voltage control.</u> The capability of VRE plants to respond to voltage fluctuations at their point of connection. Reactive power from generators assists the flow of electromagnetic energy. Variations in reactive power from generators will have an impact on local voltage.	<u>Advanced frequency and voltage controls.</u> The deployment of advanced control schemes for combined and dedicated frequency and voltage regulation.	0; Page 63
	<u>Black start.</u> The possibility of VRE resources being re-dispatched without any external voltage or power supply from the rest of the power system.	Page 60
	<u>Synthetic inertia.</u> VRE generators do not provide inertia to the system, but synthetic inertia can be engineered to improve system stability; requires advanced control methods and additional hardware components.	Page 60
	<u>Spinning Reserves.</u> The capability of quantifying, dynamically and proportionally, the spinning reserves for the expected VRE output.	0

---

	<u>Congestion Management.</u> The ability of the grid to accommodate new VRE capacity in the path of power delivery from the point of VRE connection to demand centers.	Page 64
	<u>Demand Response.</u> Demand response and energy storage are sources of power system flexibility that increase the alignment between renewable energy generation and demand.	Page 65

---

## APPENDIX A: APPLICABLE STANDARDS

For the interconnection of the VRE sources (which are generally classified as distributed resources), the following are some of the most important standards:

- 1) [IEEE 1547](#) - Standard for Interconnecting Distributed Resources with Electric Power Systems
- 2) [IEEE 1547.1](#) - Standard for Conformance Tests Procedures for Equipment Interconnecting Distributed Resources with Electric Power Systems
- 3) [IEEE 1547.2](#) - Application Guide for IEEE 1547 (see item 1)
- 4) [IEEE 1547.3](#) - Guide For Monitoring, Information Exchange, and Control of Distributed Resources Interconnected with Electric Power Systems
- 5) [IEEE 1547.4](#) - Guide for Design, Operation, and Integration of Distributed Resource Island Systems with Electric Power Systems
- 6) [IEEE 1547.6](#) - Recommended Practice For Interconnecting Distributed Resources With Electric Power Systems Distribution Secondary Networks
- 7) [IEEE P1547.7](#) - Draft Guide to Conducting Distribution Impact Studies for Distributed Resource Interconnection
- 8) [IEEE P1547.8](#) - Recommended Practice for Establishing Methods and Procedures that Provide Supplemental Support for Implementation Strategies for Expanded Use of IEEE Standard 1547

For solar power related standards, the website for IEC's technical committee TC 82 – Solar Photovoltaic Energy Systems – currently holds more than 50 international standards, technical specifications and technical reports.<sup>12</sup> Solar PV panels have become one of the most commoditized renewable energy technologies and, with a total of 121 standards identified, one of the most advanced in terms of manufacturing and testing standards. Approximately 90 percent of these standards relate to the components of PV panels, either in terms of demonstrating their performance, testing and validation of claims and manufacturing validation, or in terms of component integration and safety.

As PV systems now cover a range of applications – from standard panel modules for electricity generation to building-integrated PV – the need for more testing methods is likely to grow. New testing methods would enable manufacturers to substantiate their claims and ensure their manufacturing processes are not compromised.

In addition to the IEC standards, the following are some of the most important standards from IEEE for solar power plant design, testing, and implementation:

- 1) [IEEE 937](#) - IEEE Recommended Practice for Installation and Maintenance of Lead-Acid Batteries for Photovoltaic Systems
- 2) [IEEE 1013](#) - IEEE Recommended Practice for Sizing Lead-Acid Batteries for Stand-Alone Photovoltaic Systems
- 3) [IEEE 1361](#) - IEEE Guide for Selection, Charging, Test and Evaluation of Lead-Acid Batteries Used in Stand-Alone Photovoltaic Systems
- 4) [IEEE 1526](#) - Recommended Practice for Testing the Performance of Stand Alone Photovoltaic Systems
- 5) [IEEE 1561](#) - Guide for Optimizing the Performance and Life of Lead-Acid Batteries in Remote Hybrid Power Systems
- 6) [IEEE 1562](#) - Guide for Array and Battery Sizing in Stand-Alone Photovoltaic Systems

---

<sup>12</sup> [http://www.iec.ch/dyn/www/f?p=103:23:4499043365199::::FSP\\_ORG\\_ID,FSP\\_LANG\\_ID:1276,25](http://www.iec.ch/dyn/www/f?p=103:23:4499043365199::::FSP_ORG_ID,FSP_LANG_ID:1276,25).

- 
- 7) [IEEE 1661](#) - Guide for Test and Evaluation of Lead-Acid Batteries Used in Photovoltaic (PV) Hybrid Power Systems
  - 8) [IEEE 2030](#) - Guide for Smart Grid Interoperability of Energy Technology and Information Technology Operation with the Electric Power System (EPS), and End-Use Applications and Loads
  - 9) [IEEE P2030.1](#) - Draft Guide for Electric-Sourced Transportation Infrastructure
  - 10) [IEEE P2030.2](#) - Draft Guide for the Interoperability of Energy Storage Systems Integrated with the Electric Power Infrastructure
  - 11) [IEEE P2030.3](#) - Draft Standard for Test Procedures for Electric Energy Storage Equipment and Systems for Electric Power Systems Applications.

IEC's technical committee TC 88 – Wind Turbines – has published, or is in the developmental stage of publishing, 21 standards and technical specifications for large- and small-scale wind turbines.<sup>13</sup> These standards cover both on- and offshore applications.

Wind standards have been described by many small manufacturers and developers as “too onerous”. This is primarily because for a long time there were no requirements in many countries for independent verification of the performance, durability and reliability of wind turbine products. brought with it a new emphasis on ensuring value in terms of energy and carbon savings for the money spent by governments. Not many industries in the world have been able to produce and install equipment while only offering estimates of the equipment's likely performance. However, that situation is changing with the introduction of certified products in the wind turbine industry. Certification and a need for more accurate performance data have now led to the development of standards for small- and medium-size wind turbine.

The following is a list of some important standards for wind power plant design, testing, and implementation:<sup>14</sup>

- 1) IEC 61400-22 Ed. 1.0 b:2010. *Wind turbines - Part 22: Conformity testing and certification*. This standard “defines rules and procedures for a certification system for wind turbines (WT) that comprises both type certification and certification of wind turbine projects installed on land or off-shore. This system specifies rules for procedures and management for carrying out conformity evaluation of WT and wind farms, with respect to specific standards and other technical requirements, relating to safety, reliability, performance, testing and interaction with electrical power networks.”
- 2) IEC 61400-23 Ed. 1.0 en:2014. *Wind turbines - Part 23: Full-scale structural testing of rotor blades*. This standard “defines the requirements for full-scale structural testing of wind turbine blades and for the interpretation and evaluation of achieved test results. The standard focuses on aspects of testing related to an evaluation of the integrity of the blade, for use by manufacturers and third-party investigators. The following tests are considered in this standard: static load tests; fatigue tests; static load tests after fatigue tests; tests determining other blade properties. The purpose of the tests is to confirm to an acceptable level of probability that the whole population of a blade type fulfils the design assumptions.”
- 3) IEC 61400-24 Ed. 1.0 en:2010. *Wind turbines - Part 24: Lightning protection*. This standard “applies to lightning protection of wind turbine generators and wind power systems. Defines the lightning environment for wind turbines and application of the environment for risk assessment

---

<sup>13</sup> [http://www.iec.ch/dyn/www/f?p=103:23:4499043365199:::FSP\\_ORG\\_ID,FSP\\_LANG\\_ID:1282,25](http://www.iec.ch/dyn/www/f?p=103:23:4499043365199:::FSP_ORG_ID,FSP_LANG_ID:1282,25)

<sup>14</sup> Descriptive text is taken from abstracts of each standard available at <https://webstore.iec.ch>.

---

for the wind turbine. Defines requirements for protection of blades, other structural components and electrical and control systems against both direct and indirect effects of lightning. Recommends test methods to validate compliance. Provides guidance on the use of applicable lightning protection, industrial electrical and EMC standards including earthing. Provides guidance regarding personal safety. Makes normative references to generic standards for lightning protection, low-voltage systems and high-voltage systems for machinery and installations and EMC."

- 4) IEC 61400-25-1 Ed. 2.0 b:2017. *Wind energy generation systems - Part 25-1: Communications for monitoring and control of wind power plants - Overall description of principles and models*. This standard "gives an overall description of the principles and models used in the IEC 61400-25 series, which is designed for a communication environment supported by a client-server model. Three areas are defined, that are modelled separately to ensure the scalability of implementations: wind power plant information models, information exchange model, and mapping of these two models to a standard communication profile. This new edition includes the following significant technical changes with respect to the previous edition: general harmonization of text and overview models with the other parts of the IEC 61400-25 series, harmonization of definitions in other related standards.
- 5) IEC 61400-25-2 Ed. 2.0 b:2015. *Wind turbines - Part 25-2: Communications for monitoring and control of wind power plants - Information models*. This standard "specifies the information model of devices and functions related to wind power plant applications. In particular, it specifies the compatible logical node names, and data names for communication between wind power plant components. This includes the relationship between logical devices, logical nodes and data. The names defined in the IEC 61400-25 series are used to build the hierarchical object references applied for communicating with components in wind power plants. Main changes with respect to the previous edition consist of: harmonization with newer editions of IEC 61850 standards; reduction of overlap between standards and simplification by increased referencing, extension of data objects for operation of smart grids, extended and enhanced semantics for existing data objects, etc."
- 6) IEC 61400-25-3 Ed. 2.0 b:2015. *Wind turbines - Part 25-3: Communications for monitoring and control of wind power plants - Information exchange models*. This standard "specifies an abstract communication service interface describing the information exchange between a client and a server for: data access and retrieval, device control, event reporting and logging, self-description of devices (device data dictionary), data typing and discovery of data types. Main changes with respect to the previous edition consist of: harmonization with newer editions of IEC 61850 standards; reduction of overlap between standards and simplification by increased referencing, etc."
- 7) IEC 61400-25-4 Ed. 2.0 b:2016. *Wind energy generation systems - Part 25-4: Communications for monitoring and control of wind power plants - Mapping to communication profile*. This standard "specifies the specific mappings to protocol stacks encoding the messages required for the information exchange between a client and a remote server for: data access and retrieval, device control, event reporting and logging, publisher/subscriber, self-description of devices (device data dictionary), data typing and discovery of data types. The mappings specified in this part of IEC 61400-25 comprise: a mapping to SOAP-based web services, a mapping to OPC/XML-DA, a mapping to IEC 61850-8-1 MMS, a mapping to IEC 60870-5-104, a mapping to DNP3. The main technical changes with regard to the previous edition are as follows: general harmonization with information models in IEC 61400-25-2 and information exchange services in

---

IEC 61400-25-3; reduction of overlap between standards and simplification by increased referencing.”

- 8) IEC 61400-25-5 Ed. 1.0 en:2006. *Wind turbines - Part 25-5: Communications for monitoring and control of wind power plants - Conformance testing*. This standard “specifies standard techniques for testing of conformance of implementations, as well as specific measurement techniques to be applied when declaring performance parameters. The use of these techniques will enhance the ability of users to purchase systems that integrate easily, operate correctly, and support the applications as intended.”
- 9) IEC 61400-25-6 Ed. 2.0 en:2016. *Wind energy generation systems - Part 25-6: Communications for monitoring and control of wind power plants - Logical node classes and data classes for condition monitoring*. This standard “specifies the information models related to condition monitoring for wind power plants and the information exchange of data values related to these models. This standard is to be used with other standards of the IEC 61400-25 series. This new edition includes the following significant technical changes with respect to the previous edition: major restructuring of the data model to accommodate flexibility; removal of UFF58 format; access to data using the standard reporting and logging functions; recommendations for creating data names to accommodate flexibility.”
- 10) IEC/TS 61400-26-1 Ed. 1.0 en:2011. *Wind turbines - Part 26-1: Time-based availability for wind turbine generating systems*. This standard “defines generic information categories to which fractions of time can be assigned for a wind turbine generating system (WTGS) considering internal and external conditions based on fraction of time and specifying the following: generic information categories of a WTGS considering availability and other performance indicators; information category priority in order to discriminate between concurrent categories; entry and exit point for each information category in order to allocate designation of time; informative annexes providing various examples.”

---

# APPENDIX B: ADVANCED VRE INTERCONNECTION REQUIREMENTS

This annex lists additional, optional requirements for VRE interconnection that may be incorporated into system design where feasible.

## BLACK-START CAPABILITY

*Black start* refers to the process of restoring a power plant or a part of a power grid to operation without relying on the external power transmission network. As with hydro or thermal generation, VRE plants would be recommended to have black-start capability, as a part of their overall active-power management, in the event of large disturbances in the power system to which they are connected; otherwise, some loads could remain without supply for a long period. Black-start capability becomes essential (and is thus strongly recommended) when there is a fairly high level of VRE penetration into the grid.

## FREQUENCY RESPONSE AND CONTROL

### *Synthetic Inertia*

The speed of modern converter-controlled wind turbines is almost completely decoupled from the grid frequency. Therefore, wind turbines do not possess a natural response to frequency excursions. However, various control concepts can enable wind turbines to participate in grid frequency control, including the following:

- 1) The use of pitch control together with the provision of reserve capacity by operating the wind turbine in part-load mode.
- 2) The use of a wind turbine's kinetic energy to provide frequency support for a limited time following a disturbance. This may involve a control scheme that initiates the partial release of kinetic energy immediately after the frequency drop is detected. Replenishing the stored energy (and thus accelerating the wind turbine) then follows during the frequency recovery phase. Another possibility is for the wind turbine to accelerate first, and then decelerate by discharging energy during the phase of the disturbance in which the frequency is approaching its minimum, thus helping to limit the frequency drop.

The fastest power reserves employed to balance sudden changes in load or generation usually need a few seconds until the reserve power is activated. It is vital that this delay be tuned to the maximum rate of change of frequency (RoCoF) expected in the system to limit the magnitude of any frequency excursion.

The RoCoF primarily depends on the inertia of the rotating masses of the synchronous generators connected to the system, and on the magnitude of the power imbalance. VRE generators usually do not provide inertia. At high instantaneous penetrations of VRE generation, the remaining conventional generation with synchronous generators may not provide enough inertia. The RoCoF might then be too high for the system to remain within the designated frequency limits in the case of the highest expected imbalance. This is a factor causing must-run conventional capacity in the system.

Advanced control methods employed by VRE generator control systems can allow the implementation of inertia, or so-called synthetic inertia, from VRE generation. Such an implementation requires

significant design effort and may also necessitate additional hardware components, so agreeing on rules for future grid codes will involve considerable research, development and discussion. Once achieved, these rules will help raise the limits of achievable VRE penetration levels.

### ***Over-Frequency Control***

In order to handle over-frequency disturbances (>50.0/60.0 Hz), every wind generator within a wind power plant must be equipped with a frequency control system with a permanent droop adjustable over a range of at least 0 to 5 percent and a dead band adjustable between 0 and 10 percent of nominal frequency.

### ***Under-Frequency Control***

In the specific case of Types 3 and 4 wind turbine generators, under-frequency disturbances can be controlled by a synthetic (or emulated) inertia from the wind turbines. With this type of frequency control, the necessary inertia resides in the rotating masses of each wind turbine on line and is thus temporary. This control system is designed to handle only significant frequency variations following a major loss of generation on the power system, but it must remain in service continuously.

The synthetic inertia takes the form of an overproduction (active power) released in a controlled way shortly after a frequency dead band is reached, attaining a maximum level maintained for a specified period of time before ramping back down towards initial level. During the overproduction, the turbine rotor will normally decelerate; once the overproduction is terminated, a recovery phase is likely to follow to allow the rotor to reaccelerate. During this recovery phase, the power output is decreased to a level lower than that prevailing before the instant of the activation of synthetic inertia.

However, in a wind power plant, not all wind turbines are operated at the same power output at a given time. Some turbines may have their blades pitched so as to limit the power output to their rated capacity. These turbines can provide synthetic inertia simply by using the extra energy available in the wind, and then the recovery phase can be avoided. Care must be taken in specifying the requirement that fixes the amount of power decrease during the recovery phase as this can cause the system frequency to experience a second dip (so-called “double-dip” behavior). Moreover, a varying wind speed will impact the behavior of the inertia response. **FIGURE B.1** illustrates an example of linearized profile of the inertia requirement, in accordance with the points listed below.

**FIGURE B.1: Linearized Inertia Requirement from Wind Power Plants**

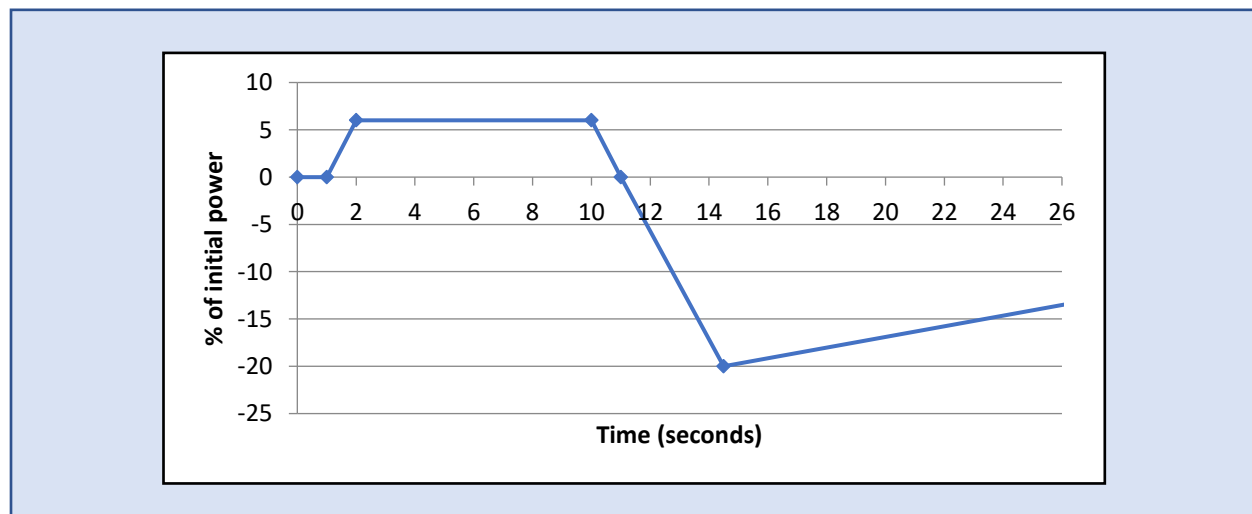

- 
- 7) Operational for every wind generator in service whenever their generation level reaches approximately 25 percent of the rated power
  - 8) Able to operate repeatedly with a 2-minute delay between the end of the recovery period and the next operation

The above requirements are those used by Hydro-Quebec and tailored for its particular system. In addition, they must be seen as a general guideline to achieving frequency control during under-frequency disturbances. The specific parameters can be adjusted to some extent to shape the frequency according to the system's electromechanical dynamic characteristics and needs. Wind power plant performance should take precedence over individual wind generator performance.

Frequency control can also be achieved by imposing a permanent reduction of the output generation of each wind turbine on line in the wind power plant, similar to an operating reserve. With this strategy, the active power can easily be increased, for a given time, when the system frequency drops below nominal, since it is readily available. The disadvantage of this strategy is that it sheds a portion of the energy, which is costly – although this can be mitigated if the system operator limits the use of the inertia requirement to only those specific times and conditions when the system is most vulnerable to frequency disturbances.

The inertia requirement associated with this strategy should be similar to that used for over-frequency control – namely, to provide a frequency control system with a permanent droop adjustable over a range of at least 0 to 5 percent and a dead band adjustable between 0 and 10 percent of nominal frequency.

### ***Automatic Generation Control***

Historically, VREs have not participated in market-based frequency regulation, even though wind turbines made by many of the leading manufacturers are able to control their active power output, and recent studies have shown that as long as there is adequate wind resources exist, wind turbines can track power commands rapidly and accurately. The wind turbine control system is capable of providing active power control services, and can be used to track automatic generation control (AGC) power commands.

AGC uses real-time data (such as frequency, status, and generation) from different units to adjust their power output in order to optimize operations and maintain power system frequency. Control signals are automatically sent to generators to cause an increase or decrease in power output to match the changing load conditions and keep the frequency within specified limits. In automatically controlled power systems, the number of dispatchable generators under AGC can be increased, and the control algorithms can be optimized to ensure adequate regulation while ensuring that dispatching is as economic as possible.

As the variability and uncertainty of the net load increases with increased share of VRE, and manual control of generators becomes more difficult, it is reasonable to introduce automated control systems – not only for synchronous machines, but also for VREs. The participation of VREs in frequency regulation requires that each wind power plant establish communication with the system operator to receive the power dispatch schedule, the regulation capacity, and the AGC power command. The wind power plant control system sends power commands to the individual turbines, which need not be uniform.

Xcel Energy Colorado installed AGC systems at four wind facilities in Colorado to enable the system operator to ramp down the output from these wind facilities automatically during certain periods. Today, two-thirds of Xcel Energy's wind turbines in Colorado are equipped with AGC controls and provide regulation. Furthermore, advancements in power electronics have enabled operators to provide

frequency control through wind plants by extracting stored inertial energy from the wind turbines. The response time of these wind turbines (within 10-15 seconds following a large frequency dip) is faster than the traditional governor response of larger conventional thermal-generation resources, and has proved to actually improve system performance.

A brief discussion of grid code requirements for frequency control in different countries with respect to VRE is provided in Molina and Alvarez (2011). In some countries, VREs are exempted from the obligation to supply primary reserves, and they may not even offer any capacity as reserve power or regulating power to the transmission system operator. In other countries, such as Germany, Ireland and Denmark, grid codes demand that wind farms have the ability to restrict active power. The British grid code requires that wind farms have a frequency control device capable of supplying primary and secondary frequency control, as well as over-frequency control. As a general remark, it is clear that most grid codes require wind farms (especially those of high capacity) to provide frequency response, i.e., to contribute to the regulation of system frequency. It is also emphasized (Molina and Alvarez 2011) that the active power ramp rates must comply with the respective rates applicable to conventional power units.

**REACTIVE POWER CAPABILITIES FOR VOLTAGE CONTROL**

VRE generators should be equipped with an automatic voltage regulation system. It must be able to supply and absorb the amount of reactive power corresponding to a leading and lagging power factor less than or equal to 0.95, as seen at the POI. The voltage regulation system must have a permanent droop adjustable between 0 and 10 percent.

Reactive power should be available, at the POI, over the full voltage and frequency range under normal operating conditions (voltage: 0.9–1.1 p.u.; frequency: ±1 percent of nominal). However, at voltages less than 0.95 p.u., a VRE generator is not required to absorb reactive power corresponding to a lagging power factor of 0.95 (as shown in FIGURE B.2). It still must be able to supply reactive power corresponding to a leading power factor of 0.95. Similarly, at voltages greater than 1.05 p.u., a VRE generator is not required to supply reactive power corresponding to a leading power factor of 0.95, but it still must be able to absorb the reactive power corresponding to a lagging power factor of 0.95.

**FIGURE B.2: Reactive Power Available at POI vs. Voltage**

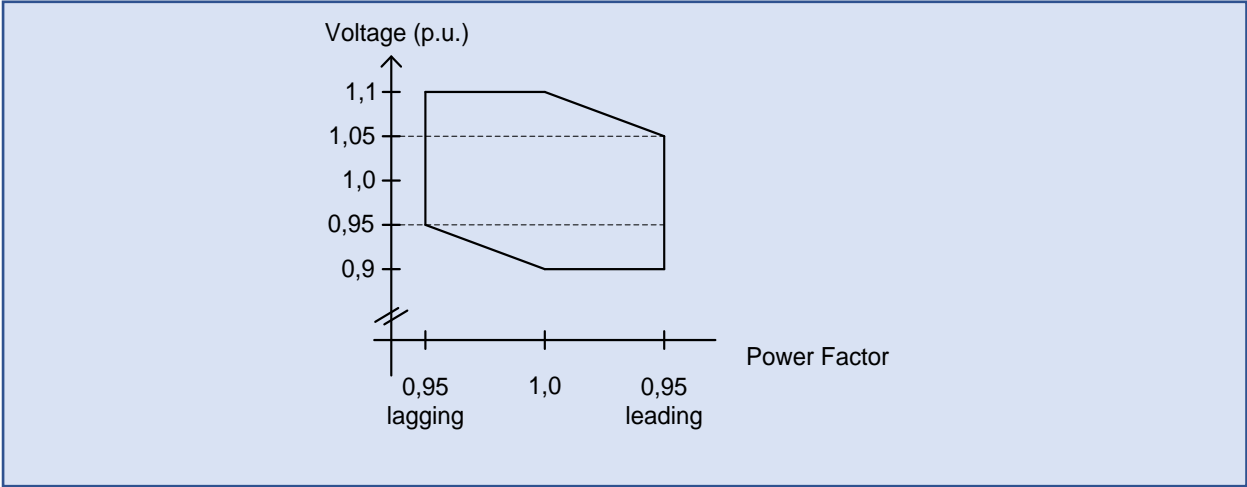

In addition, the reactive power available at the POI, with relation to the variable active power of VRE generators in service, should be at least 0.33 p.u. (i.e., an equivalent power factor of 0.95) of the rated

capacity of the VRE generators in service, as shown in FIGURE B.3. The minimum active power threshold at which the reactive power must be fully available may vary but should not be higher than 0.15.

**FIGURE B.3: Reactive Power Available at POI vs. Active Power of VRE**

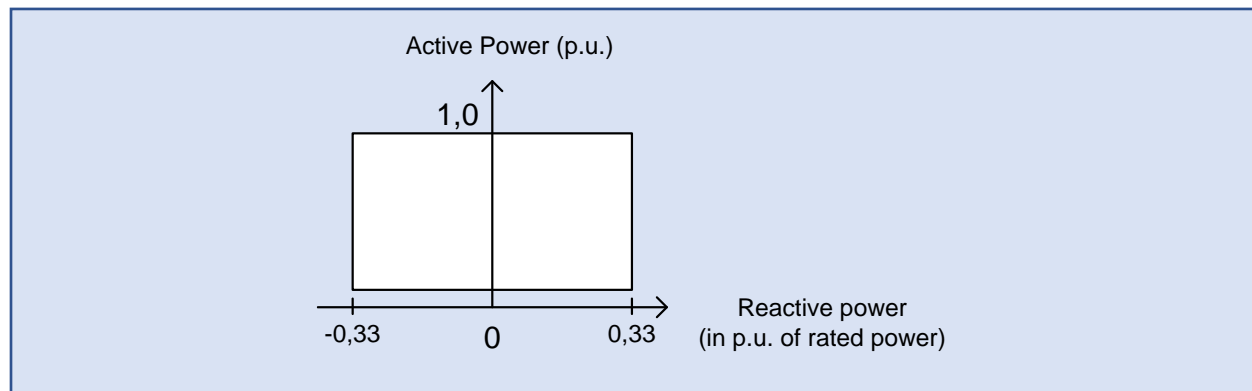

### CONGESTION MANAGEMENT

The ability of the grid to accommodate new VRE capacity may not only be constrained at the point of connection, but also may constrain the path of power delivery from the point of VRE connection to demand centers. The grid “congestion” bottlenecks usually reflect lines that have a lower capability to transmit power than the surrounding grid as they carry an amount of power close to their thermal limit. As a result, the output of power plants on one side may have to be curtailed, while on the other side others may have to be ramped up. Such “re-dispatching” of plants is usually suboptimal, because low price energy from wind or solar plant is curtailed on one side of the bottleneck while a fuel-based power plant is re-dispatched upwards on the other, which generally increases the transmission losses. Grid congestion is likely to occur as a result of the deployment of new VRE generation capacity in parts of the grid that have previously seen limited or no locally connected power plants. The wind or solar resource can differ quite dramatically across the area linked by a grid (although this variation is less likely in the case of solar PV).

Grid reinforcement is usually required to mitigate serious congestion of the grid. However, opportunities to disperse VRE power plants geographically (geo-spread) and to smooth their output over time (technology spread) – thus making better use of existing surplus capacity – should be fully explored at the same time as measures to manage existing and emerging bottlenecks are considered. Before pursuing grid reinforcement, a comprehensive analysis has to be carried out to identify weak elements of the infrastructure that may cause bottlenecks. Implementation of FACTS devices can significantly enhance the control and stability of the power system, increase its ability to carry power by flexibly regulating the reactive, and to some extent active power, injected or absorbed at grid nodes (ESMAP 2019a).

### DEMAND RESPONSE

Demand response and energy storage are enabling technologies that can reduce curtailment and facilitate higher penetrations of VRE on the grid. They are sources of power system flexibility that increase the alignment between renewable energy generation and demand. Demand response (DR) is playing an increasing role in providing capacity, but also in mitigating shorter-term events, potentially impacting reliability. While DR is primarily used as a capacity resource – i.e., as a way of ensuring that the combination of supply resources and DR is sufficient to maintain a stable supply of electricity,

---

particularly during the periods of highest demand – it is also used for emergency situations, such as when generation outages lead to relatively short-term supply shortages.

Many DR programs limit the number of times, and define lengths of time, for such calls (requests) each year and do not require advanced technology. For example, interruptible load contracts using some form of direct load control (DLC) have been around for many years. These types of “traditional” DR can help grid operators manage any relatively rapid and unexpected changes in the output from VRE sources. In the future, however, advances in technology such as smart meters (defined as meters that measure consumption at frequent intervals and/or allow for frequent bidirectional communication), home energy management systems, smart appliances, and so on will increasingly create additional opportunities to use DR in situations other than emergencies. More robust DR can therefore make a significant contribution to integrating larger amounts of renewables.

---

## REFERENCES

- Ackermann, T., Martensen, N., Brown, T., Schierhorn, P.-P., Boshell, F., Gafaro, F. and Ayuso, M. 2016. Scaling up Variable Renewable Power: The Role of Grid Codes. Abu Dhabi, United Arab Emirates: IRENA. Accessible via: <http://www.irena.org/publications/2016/May/Scaling-up-Variable-Renewable-Power-The-Role-of-Grid-Codes>.
- ASTM International. 2011. ASTM E2848-11, Standard Test Method for Reporting Photovoltaic Non-Concentrator System Performance. West Conshohocken, USA: ASTM International. Accessible via: <https://www.astm.org/DATABASE.CART/HISTORICAL/E2848-11.htm>.
- Barbados Light and Power Company Limited. 2014. GRID CODE: Interconnection Requirements at Voltages 24.9kV and Below. St. Michael, Barbados: Barbados Light and Power Company Limited. Accessible via: <https://www.blpc.com.bb/images/brochures/GRID-CODE-Rev1-May%2020141.pdf>.
- CIGRE (International Council on Large Electric Systems). 2015. B4.55 HVDC connection of offshore wind power plants. Paris, France: Cigre. Accessible via: <http://www.ee.co.za/article/hvdc-connection-offshore-wind-power-plants.html>.
- Corfee, K., Korinek, D., Cassel, W., Hewicker, C., Zillmer, J., Morgado, M. P., Ziegler, H., Tong, N., Hawkins, D. and Cernadas, J. 2011. Distributed Generation in Europe: Physical Infrastructure and Distributed Generation Connection. KEMA Topical Memo, KEMA, Inc. Accessible via: [http://www.clean-coalition.org/site/wp-content/uploads/2012/11/Memo-1\\_Physical-Infrastructure-and-DG-Interconnection.pdf](http://www.clean-coalition.org/site/wp-content/uploads/2012/11/Memo-1_Physical-Infrastructure-and-DG-Interconnection.pdf).
- Cunningham, J., Hernday, P. & Mokri, J. 2014. Commissioning for PV Performance. San Jose, USA: SunSpec Alliance. Accessible via: <https://sunspec.org/wp-content/uploads/2015/06/SunSpec-Best-Practice-Guide-Commissioning-for-PV-Performance-D42039-1.pdf>.
- ERCOT (Electric Reliability Council of Texas). 2012. Guide to the Interconnection Process. Austin, USA: ERCOT. Accessible via: [http://www.ercot.com/services/rq/re/reg/GUIDE\\_TO\\_THE\\_INTERCONNECTION\\_PROCESS\\_v1\\_0.pdf](http://www.ercot.com/services/rq/re/reg/GUIDE_TO_THE_INTERCONNECTION_PROCESS_v1_0.pdf).
- . 2016. Future Ancillary Services: Preparing to Maintain Reliability on a Changing Grid. Austin, USA: Accessible via: [https://static1.squarespace.com/static/556efc95e4b0b54303d2a73c/t/574dcc22d210b85b4cff044a/1464716323488/FAS\\_TwoPager\\_April2016\\_FINAL.pdf](https://static1.squarespace.com/static/556efc95e4b0b54303d2a73c/t/574dcc22d210b85b4cff044a/1464716323488/FAS_TwoPager_April2016_FINAL.pdf)
- ESMAP (Energy Sector Management Assistance Program) 2019a. “Compensation Devices to Support Grid Integration of Variable Renewable Energy.” ESMAP Guidance Note, World Bank, Washington, DC.
- . 2019b. “Studies for Grid Connection of VRE Generation Plants.” ESMAP Technical Guide, World Bank, Washington, DC.
- GWEC (Global Wind Energy Council) 2017. Global Wind Report 2016 - Annual Market Update. Brussels, Belgium: GWEC. Accessible via: <https://gwec.net/publications/global-wind-report-2/global-wind-report-2016/>.
- IEA (International Energy Agency). 2016. Next Generation Wind and Solar Power. From cost to value. Paris, France: OECD/IEA. Accessible via: [https://www.iea.org/publications/freepublications/publication/Next\\_Generation\\_Windand\\_Solar\\_PowerFrom\\_Cost\\_to\\_ValueFull\\_Report.pdf](https://www.iea.org/publications/freepublications/publication/Next_Generation_Windand_Solar_PowerFrom_Cost_to_ValueFull_Report.pdf).

- 
- — — 2017. Getting Wind and Sun onto the Grid: A Manual for Policy Makers. Paris, France: OECD/IEA. Accessible via: [https://www.iea.org/publications/insights/insightpublications/Getting\\_Wind\\_and\\_Sun.pdf](https://www.iea.org/publications/insights/insightpublications/Getting_Wind_and_Sun.pdf).
- IEC (International Electrotechnical Commission). 2009. Grid Connected Photovoltaic Systems—Minimum Requirements for System Documentation, Commissioning Tests and Inspection. IEC Standard 62446. Geneva, Switzerland: IEC.
- IFC (International Finance Corporation). 2015. Utility-Scale Solar Photovoltaic Power Plants: A Project Developer’s Guide. Washington, D.C.: IFC. Accessible via: [https://www.ifc.org/wps/wcm/connect/f05d3e00498e0841bb6fbb54d141794/IFC+Solar+Report\\_Web+\\_08+05.pdf?MOD=AJPERES](https://www.ifc.org/wps/wcm/connect/f05d3e00498e0841bb6fbb54d141794/IFC+Solar+Report_Web+_08+05.pdf?MOD=AJPERES).
- IRENA (International Renewable Energy Agency). 2015. Renewable Energy Integration in Power Grids. Technology Brief. Abu Dhabi, United Arab Emirates: IRENA. Accessible via: [http://www.irena.org/-/media/Files/IRENA/Agency/Publication/2015/IRENA-ETSAP\\_Tech\\_Brief\\_Power\\_Grid\\_Integration\\_2015.pdf](http://www.irena.org/-/media/Files/IRENA/Agency/Publication/2015/IRENA-ETSAP_Tech_Brief_Power_Grid_Integration_2015.pdf).
- — — . 2018. Renewable Capacity Statistics 2018. Abu Dhabi, United Arab Emirates: IRENA. Accessible via: <https://www.irena.org/publications/2018/Mar/Renewable-Capacity-Statistics-2018>.
- Jain, P. and Wijayatunga, P. 2016. Grid Integration of Wind Power. Best Practices for Emerging Markets. ADB Sustainable Development Working Paper Series No. 43, April. Manila, Philippines: Asian Development Bank. Accessible via: <https://www.adb.org/sites/default/files/publication/183785/sdwp-043.pdf>.
- Molina, M.G. and Alvarez, J.G. 2011. Technical and Regulatory Exigencies for Grid Connection of Wind Generation. San Juan, Argentina: Universidad Nacional de San Juan. Accessible via: <https://www.intechopen.com/books/wind-farm-technical-regulations-potential-estimation-and-siting-assessment/technical-and-regulatory-exigencies-for-grid-connection-of-wind-generation>.
- Mokri, J. and Cunningham, J. 2014. PV System Performance Assessment. San Jose, USA: SunSpec Alliance. Accessible via: <https://sunspec.org/wp-content/uploads/2015/06/SunSpec-PV-System-Performance-Assessment-v2.pdf>.
- NERC (North American Electric Reliability Corporation). 2007. Reliability Concepts. Version 1.0.2. Atlanta, USA: NERC. Accessible via: [https://www.nerc.com/files/concepts\\_v1.0.2.pdf](https://www.nerc.com/files/concepts_v1.0.2.pdf).
- — — . 2009. Accommodating High Levels of Variable Generation. IVGTF (Integration of Variable Generation Task Force) Report. Atlanta, USA: NERC. Accessible via: [https://www.nerc.com/files/ivgtf\\_report\\_041609.pdf](https://www.nerc.com/files/ivgtf_report_041609.pdf).
- — — . 2012. Special Reliability Assessment: Interconnection Requirements for Variable Generation. Atlanta, USA: NERC. Accessible via: [https://www.nerc.com/pa/RAPA/ra/Reliability%20Assessments%20DL/2012\\_IVGTF\\_Task\\_1-3.pdf](https://www.nerc.com/pa/RAPA/ra/Reliability%20Assessments%20DL/2012_IVGTF_Task_1-3.pdf).
- New Energy Update. 2017. Global solar installs forecast at 90 GW/year; US energy groups file case against coal support. London, UK: New Energy Updated. Retrieved from: <http://newenergyupdate.com/pv-insider/global-solar-installs-forecast-90-gwy-year-us-energy-groups-file-case-against-coal-support>.
- NREL (National Renewable Energy Laboratory). 2013. Photovoltaic Module Qualification Plus Testing. Golden, USA: NREL. Accessible via: <https://www.nrel.gov/docs/fy14osti/60950.pdf>.
- PacifiCorp. 2016. Technical Specifications for Wind and Solar Power Plants. Portland, USA: Pacificorp.
- Schubel, P.J. and Crossley, R. J. 2012. Wind Turbine Blade Design. Basel, Switzerland: Energies. Accessible via: <https://www.mdpi.com/1996-1073/5/9/3425>.

---

Simani, S. 2015. Overview of Modelling and Advanced Control Strategies for Wind Turbine Systems. Basel, Switzerland: Energies. Accessible via: [10.3390/en81212374](https://doi.org/10.3390/en81212374).

SMA Solar Technology AG. n.d. Performance Ratio. Quality Factor for the PV Plant. Technical Brochure. Hesse, Germany. Accessible via: <http://files.sma.de/dl/7680/Perfratio-TI-en-11.pdf>.